

# YOUR DESIRE OUR MISSION

**INDEPENDENT LAB WITH GLOBAL REACH**

**AN EXPERIENCED HIGH QUALITY**

**SWISSCOAT<sup>®</sup>**  
Better Vision 



**SWITZERLAND**

**FRANCE**

**CHINA**

**HONG KONG**

**CANADA**

# CONTENT PAGE

<b>COMPANY BACKGROUND</b>	04 - 07	<b>PROGRESSIVE</b>	45 - 46	• SafeWear	78
<b>TECHNOLOGY</b>	08 - 09	• Conventional Progressive		• ActiveWear	78
<b>LENS TYPE</b>	10 - 11	- Minipro	47	• Nxt	79 - 81
<b>MONO LIFESTYLE</b>	12	- Genius	48	• Armour UV++	82
• Single Vision - SoloTECH	13	• High Definition Progressive		• Armour Sun UV++	83
• SoloTECH TM	14 - 16	- NECO	49	• SunAdapt	84
• iRelax	17 - 18	• Precision Progressive		• Transitions Signature Gen8	85
<b>MYOPIA MONITORING</b>	19	- Daily/Sport/Advance	50 - 52	• Transitions XTRActive	86
• KidsPro	20 - 21	• My World Progressive		• Sundance Color Photochromic	87
• Kids Protech	22 - 23	- iFree (Mobile/Soft/Advance)	53 - 54	• Nupolar	88
• MYO Protech	24 - 27	• Smart Evolution Progressive		• Drivewear	89
<b>SPORT</b>	28	- Smart E 1.0	55 - 60	<b>MINERAL GLASSES</b>	90 - 91
• iAction	29 - 30	- Smart E 2.0	61 - 64	<b>SUNRANGE</b>	92 - 93
• iActionTM	31 - 33	- Smart E 3.0	65 - 67	• Sunsport Mirror	94
<b>BIFOCAL</b>	34	- Smart E Drive	68 - 69	• Color Tint	95
• Flat-Top	35	<b>PREMIUM COATING</b>	70	• Sun Filter Lens	96
• Curve-Top	35	• Standard Anti-reflective Coating	71	<b>LENS RANGE AVAILABILITIES</b>	97 - 108
• Kry-Top	35	• SPC 2.0 New Advanced Coating	71	<b>OTHER INFORMATION</b>	109
• Young Bifocal	35	• Maxiivue (MV3.0)	72	• Lens Index Chart	110
• Digital Seamless	36 - 37	• StressFree	72	• Centraction Chart	111 - 114
<b>THE INDOOR</b>	38	• ImpactFREE	73	• Lens Design Engraving	115
• Conventional Office	39 - 40	<b>LENS MATERIAL</b>	74 - 75	• Lens Engraving Chart	116 - 117
• Precision Office	41 - 42	• Plastic	76		
• iRoom/iOffice/iReader	43 - 44	• Mineral	77		

# COMPANY BACKGROUND

## Company Brief

SWISSCOAT Laboratory, established in 1989, with over 30 years' sustainable development, a comprehensive Rx Lens laboratory focusing on the production of full scope of lens product and service. Over 30 years, we have developed a very strong dedicated workforce, experienced management team, mature and efficient logistic system to work 24 hours in order to supply the fastest and quality Rx lens service to all customers. We have developed a strong R&D development team, SWISSCOAT team and working labors are all professional trained expertise on lens knowledge and production. We offer the most comprehensive Rx lens products and service portfolio to the market. The laboratory is located in a new 200,000 sq feet, a state-level new industrial area. Till now we have daily Rx production capacity of 10,000 pieces per day.



200,000 Square feet Rx Production Site



ASPAC Head Office



# COMPANY BACKGROUND

## Product And Service Brief

SWISSCOAT offers all kinds of indexes and material (Mineral, Plastic, Trivex and Polycarbonate) in Clear, Digital+ UV Block, Transitions, Polarized, Drivewear and Nxt Impact Resistant material. We supply full range of Single vision, Bifocal, Conventional progressive, High Definition progressive and Customized High Definition Progressive production in all materials and indexes. Full range of Single vision Stock lens supply is available to order. We provide full warehousing, logistic control, glazing and mounting service to customer. We are the Qualified optical serviced laboratory that has implemented and maintains a quality management which fulfills the requirement of FDA, ISO 9001:2015 and CE for the scope of Production of Rx lenses. We have developed many new products like Myopia Control monitoring lenses, Premium low reflect anti-reflective coating, digital block coating and a wide array of Rx color tinting.



## About SWISSCOAT

SWISSCOAT is a lens laboratory known for producing state-of-art optical lenses and offer customized solutions for natural and comfortable vision, wide selection of thin and light lenses, premium materials and high-tech finished. All SWISSCOAT lenses are guaranteed value for quality and money.

Enjoy quality service and exceptional high quality functional lenses from SWISSCOAT for people of all ages. Whether you're looking for a new pair of glasses or need to change your vision needs, SWISSCOAT always has the right solution. With passion, enthusiasm and wealth of knowledge, customers love our lenses.

## Lens Specialties

With a passion for eyes and plenty of experience developing the perfect lenses, SWISSCOAT is proud to offer a range of lenses, from sun lenses to regular lenses to meet customers vision needs. We consider style, practicality and function in all our designs, creating some of the most innovative designs in progressive lenses, transition shades and more

# COMPANY HISTORY

- 1991** ○ SWISSCOAT made first generation resin fiber non-reflective lens, which has an excellent market reputation.
- 1995** ○ SWISSCOAT launched a series of multi-functional specialty lenses.
- 2001** ○ SWISSCOAT took the lead to begin produce optical lenses with digital grinding methods. The power error produced can be as low as 0.01D (Note: the power error of traditional grinding lenses is as high as 0.25D), which greatly improves the accuracy of the lens. At the same time, digital polishing can be used to produce functional lenses for different purposes, such as multifunctional progressive lenses, anti-fatigue lenses, sports-specific functional lenses and children's myopia control lenses, which will help increase product diversity and expand market share.
- 2012** ○ SWISSCOAT continues to make breakthroughs and develops MV997 high-definition coated lenses. The lenses have extremely low reflection characteristics, and the pleasing appearance has successfully won many customers and users. With the success of the MV997 high-definitions lens, many new customers at home and abroad are attracted.
- 2013** ○ SWISSCOAT continues to develop kids myopia control lenses, anti-blue light coating and latest multi-focal lenses.
- 2014** ○ The Hong Kong Polytechnic University conducted clinical tests on SWISSCOAT StressFree blue light filter lens products, and the report was excellent. It successfully pushed the sales of SWISSCOAT to another peak.
- 2015** ○ The launch of the 1<sup>st</sup> generation customized lifestyle Smart Evolution 1.0 progressive product.
- 2017** ○ ImpactFREE coating is introduced to the market.
- 2018** ○ 2<sup>nd</sup> generation customized lifestyle Smart Evolution 2.0 progressive is launched.
- 2021** ○ Smart Evolution 3.0, TM thinnest technology on Specialty lenses, MYO Protech kids Myopia protective lenses are launched.



SWISSCOAT AI VISION CENTER is opened to allow more customers to experience the best of SWISSCOAT lenses. SWISSCOAT is a one stop solution provider for the optical shops and eye care provider.

# SWISSCOAT - The Rx Lens Specialist

## ONE STOP SOLUTION

### THE TOUCH OF EXCELLENCE

Your local lens partner in the global market.



### Precision Rx Production

Precision is the hallmark of our production.



Production Factory



1. Auto Blocking



2. Auto Generating

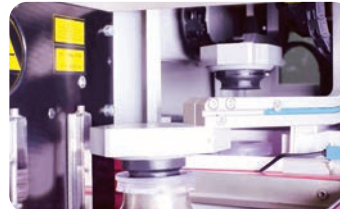

3. Auto Laser Marking



4. AR Polishing



5. AR De-Blocking

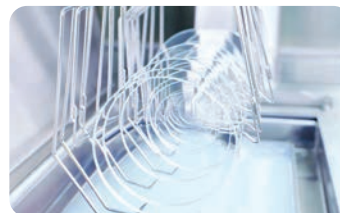

6. Hard Coating



7. AR Coating

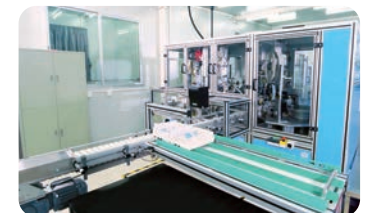

8. Auto Checking



9. Stamping



10. Auto Edging



Precision Rx

TECHNOLOGY

# SWISSCOAT ADOPTS STATE-OF-THE-ART PRECISION TECHNOLOGY IN LENS MAKING

Optimal Fit  
Technology

Optics Solution  
Technology

Advanced Lens  
Coating Technology

## All our lens products are designed and created out of innovation

We understand that all our customers, of diverse background and lifestyle needs, would have different corrective eyewear needs. Our dedication to provide a comfortable vision experience begins at the technology. As a lens specialist, we offer the right solution for glasses wearers with precisely crafted lenses that are packed with features.

Every SWISSCOAT lens product is carefully crafted with unique state-of-the art Precision Technology - each and every pair of lenses is customized to answer to the individual eyewear needs of our customers. Whether you are looking for single vision lenses, progressive lenses, or lenses with special protection functions, SWISSCOAT always has the right solution.

The strength of our precision lies in 5 core areas that we have carefully refined over the years.



Optics Solution  
Technology



Optimal Fit  
Technology



Advanced Surface  
Coating Technology



Production Engineering  
Technology



System Engineering  
Technology





# TECHNOLOGY

## MORE TECHNOLOGY INFORMATION

GO TO LANDING PAGE



Optics Solution  
Technology

[Read More](#)



Optimal Fit  
Technology

[Read More](#)



Advanced Surface Coating  
Technology

[Read More](#)



Production Engineering  
Technology

[Read More](#)



System Engineering  
Technology

[Read More](#)

SINGLE VISION  
KIDS PRO  
SMART EVOLUTION

## **LENS TYPE**

PRECISION  
YOUNG BIFOCAL  
ACTION CONTACT LENS

# SWISSCOAT The Rx Lens Specialist

Anyone into luxury visual comfort is sure to be impressed by the SWISSCOAT Precision Optics. SWISSCOAT combines pure functionality with extraordinary design that suits all today's demanding customers.

High Definition Digital Surfacing now enables the manufacturing of lenses with tremendous accuracy; ensuring lenses are produced exactly as customer's vision needs.

All SWISSCOAT lenses are available with our unique premium coating Maxiivue, StressFree and ImpactFREE coating.

Each lens is with a guaranteed level of quality and performance.

Mono Lifestyle	Myopia Monitoring	Sport	Bifocal	The Indoor	Preliminary		Advanced	Business	Platinum
					Conventional Progressive	High Definition Progressive	Precision Progressive	My World Progressive	Smart Evolution Progressive
Single Vision	KidsPro	iAction	Flat-Top	Conventional Office	Genius	NECO	Daily	iFree • Mobile • Soft • Advance	Smart E 1.0
SoloTECH	Kids Protech	iActionTM	Curve-Top	Precision Office	MiniPro		Sport		Smart E 2.0
i-Relax	MYO Protech		Kry-Top	iRoom 4m	Deluxe		Advance		Smart E 3.0
			Young Bifocal	iOffice 2m					Smart E Drive
			Digital Seamless	iReader 1.3m					

A young woman with long brown hair and glasses is smiling while looking at a tablet computer. She is wearing a white sweater. The background is a bright, blurred indoor setting, possibly a cafe or office. The text 'MONO LIFESTYLE' is overlaid on the left side of the image.

# MONO LIFESTYLE

Single Vision • SoloTECH • i-Relax

# Single Vision

SWISSCOAT assures the best quality single vision lens to the market, we offer all indexes and guarantee visual comfort and clarity.

**Conventional Lens**

**SoloTECH Lens**

**High Definition MaxiTHIN**

**Finished**  
Spheric Stock  
Aspheric Stock

**Rx Specialty**  
Spheric  
Aspheric  
Omega  
Lenticular

**Rx Specialty**  
SoloTECH  
SoloTECH Mono  
SoloTECH TM  
iRelax

**SINGLE VISION LENS**

## SoloTECH

Single vision lens by SoloTECH technology from SWISSCOAT is the highest visual quality in Single Vision lens and always manufactured using the premium material in the market, with wide selection of choice of index from 1.5 to 1.74 depending on your individual requirement. We guarantee you the excellent visual quality for demanding users of single vision lenses.

Exclusive surface optimization applied to SoloTECH design allows the highest level of visual acuity in all directions of gaze.

## SoloTECH Mono - Individual

Personalization adapting the lens to any wearer expectation.



**Visual Acuity**  
The highest level of visual acuity

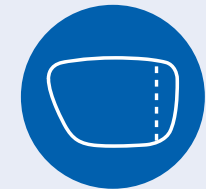

**Personalized Lens**  
Personalized lens considering the real position of wearer

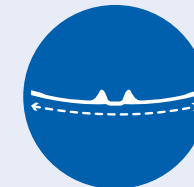

**Frames**  
Adaptable to all types of frames



**Aesthetics**  
Maximum optimization of thicknesses in positive lenses



**Sports**  
Available for Sport frames

# SoloTECH™

## SPECIALTY LENS

A pair of lenses to solve the problem of looking far and near

High myopia or aphakia patients have very high diopter, ordinary lenses can not meet the demand, SWISSCOAT can provide special customized services.

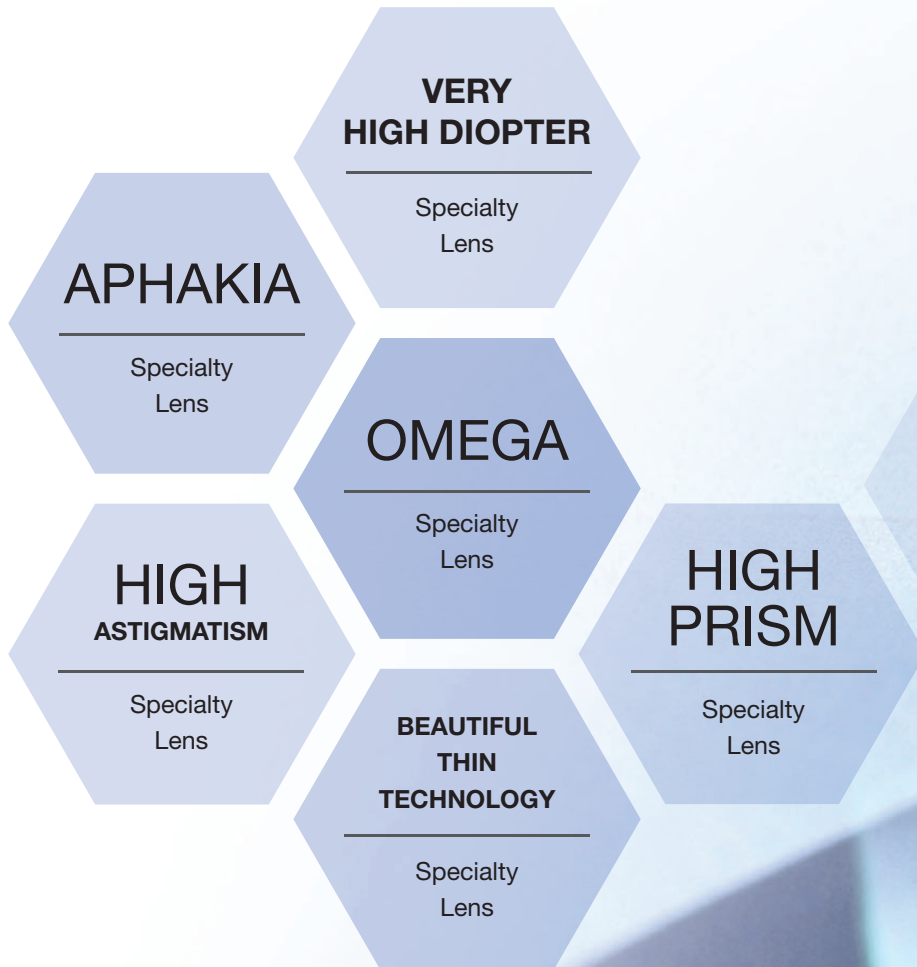

# SoloTECH™ - Specialty Lens

Patients with high hyperopia or aphakia have very high diopter, and the lenses needed are usually very thick and heavy, which greatly affects the correction and appearance.

SWISSCOAT adopt the principle of reducing the diameter of lenses, which can reduce the thickness and weight of lenses as much as possible under the premise of guaranteeing the diopter.

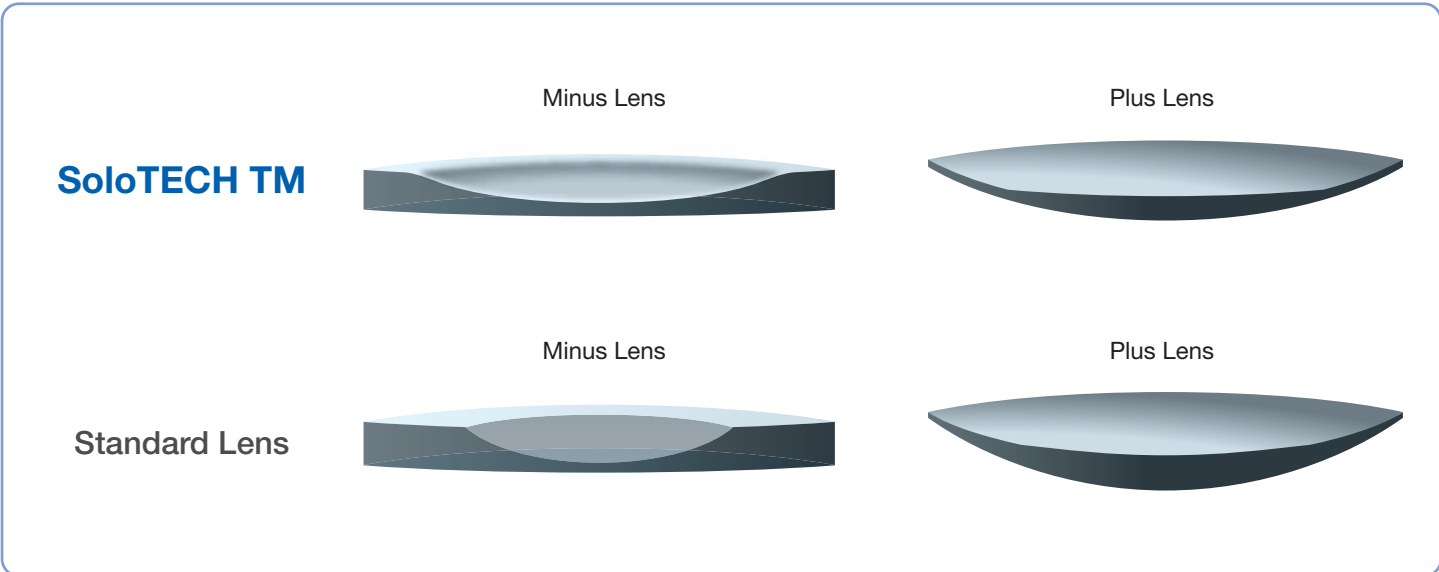

SoloTECH™ is a process developed to minimize the thickness and weight of lenses, it reduces the thickness with a gradual change in curvature, giving as a result a thinner lens in the edge for minus lenses and thinner in the center for plus lenses.

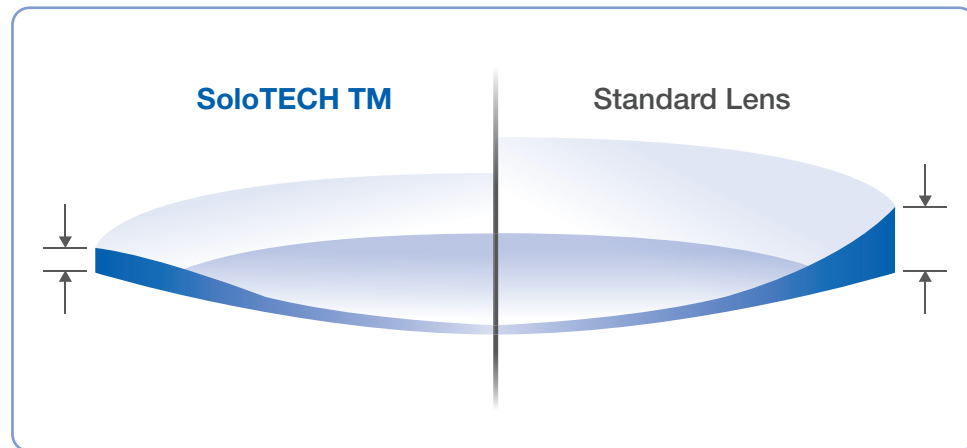

## Optical Area

Optical area is a zone where the optical quality is optimum. SoloTECH™ effect saves this area for optical vision and modifies the curvature of the lens outside the saved zone to reduce thickness.

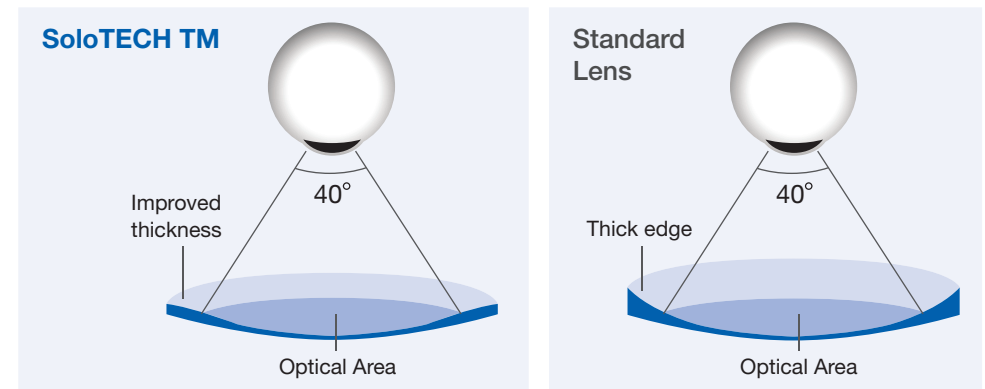

# SoloTECH ADVANTAGES

- 1 The highest level of visual acuity
- 2 Adaptable to all types of frames
- 3 Reduction of thickness on minus and plus lenses

## Fitting Tips

- 1 Same as Single Vision lens
- 2 SoloTECH TM - No compensation
- 3 Mono PD required



# iRelax

SWISSCOAT iRelax, wearers are now feeling less visual fatigue when reading or working with computers. With iRelax, you can relax your eyes during working and it is designed and calculated for reducing a visual fatigue. People between 25 and 45 years old who needs to spend long time using the near vision, working with computers and as result of it, have visual fatigue visual fatigue are ideal wearers for the iRelax.



## PROGRESSIVE ENGRAVING

Temple

Nasal >



**Standard requirement:**  
(Minimum frame height: 27mm)

**Design Option: +0.50, +0.75**

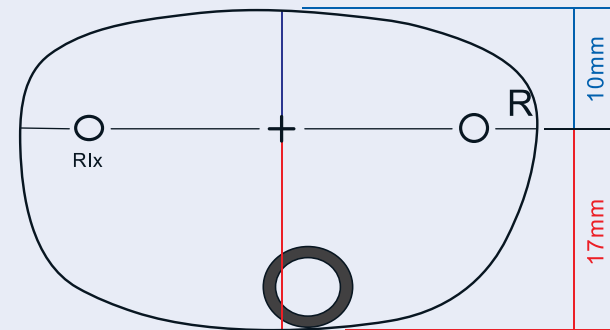

# iRelax ADVANTAGES

- 1 Free from visual fatigue
- 2 Anti-Tiredness
- 3 Comfortable
- 4 Suitable for all adult

## Fitting Tips

- 1 Fitting height: 14 to 20mm
- 2 Near inset: Available
- 3 Pantoscopic tilt: Optional
- 4 Wrapping angle: Optional
- 5 Back vertex distance: Optional
- 6 Pupil distance: Required
- 7 Power compensation: NO

A photograph of two children sitting at a desk. In the foreground, a boy with glasses and a striped shirt is looking at a laptop screen. In the background, a girl is smiling. There is a mug and some food on the desk.

# MYOPIA MONITORING

KidsPro • Kids Protech • MYO Protech

# KidsPro

SWISSCOAT KidsPro is the most advanced Myopia Control lenses that can slow the rate of Myopia progression for your child. It is specially design for the active 8 to 16 years old children.

SWISSCOAT KidsPro Myopia Control lens need to be prescribed by professional optometrists and to have always at least every 6 months check up and monitor by your optometrists in order to achieve the best result in the control of the shortsightedness.

SWISSCOAT KidsPro has all these benefits to the children who choose to wear Myopia Control Lenses:

- A shorter corridor
- A wider reading zone
- A wider far vision zone
- A softer design compared to conventional progressive lens. Eye-point Technology ensures the softest lens design for every vision zone.

With KidsPro you can fit into any small children frame, the minimum fitting height is 17mm. The short corridor enables an easy transition between the fav vision zone and the reading zone for the children. Aspheric in all its vision zones, KidsPro is the thinnest and lightest possible lens to wear.



### Pupil Distance Measurement

- When using a pupilometer for measuring pupil distance, verify the result though a manual test
- If a pupilometer is not available
  1. Positin yourself at the child's eye level
  2. Make the pupil canter on the demo lens in the frame
  3. Place the demo lens on the centration chart and read the monocula PD

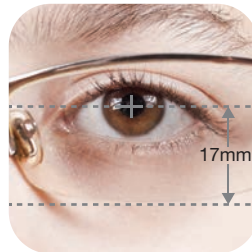

### Fitting Height Measurement

- Be aware that the fitting height can differ from eye to eye
- Position yourself at the child's eye level
  - Make the pupil canter on the demo lens in the frame
  - We recommend a minimum fitting height of 17mm

### Cut-Out Confirmation

- Check both the right and left eyes
- Align the pupil center marking over the cross in the centration chart
- Make sure the frame shape falls within the selected lens diameter



### Lens Verification

- If lenses are not maked, restore the marking with the KidsPro sticker marker
- Fit the frame with the glossed lenses on the patient and verify that the fitting cross is aligned with the pupil center

## KidsPro ADVANTAGES

- 1 Relieve the lengthening of ocular axis
- 2 Correct Myopia
- 3 Comfortable
- 4 Suitable for Myopia wearer that from 6 to 16 years old

### Fitting Tips

- 1 Same as progressive lens

# Kids ProTECH

Children’s eyes are bombarded with damaging light sources that surround us every day. From the sun’s UV rays to the tiny text in textbooks, there is always an eye-damaging source nearby. SWISSCOAT combines years of experience and expertise to design the all new Kids ProTECH, the children myopia control protective lenses that not only controls myopia progression in your child, but also protect their maturing eyes from UV, blue light, and impact resistant protective properties.

Each Kids ProTECH lens is infused with 5 major SWISSCOAT technologies:

- StressFree Anti-blue light coating
- Myopia Control design
- Armour UV++ protective lens
- ImpactFREE coating
- Clearview HD coating

## Each Kids ProTECH lens is infused with 5 major SWISSCOAT technologies

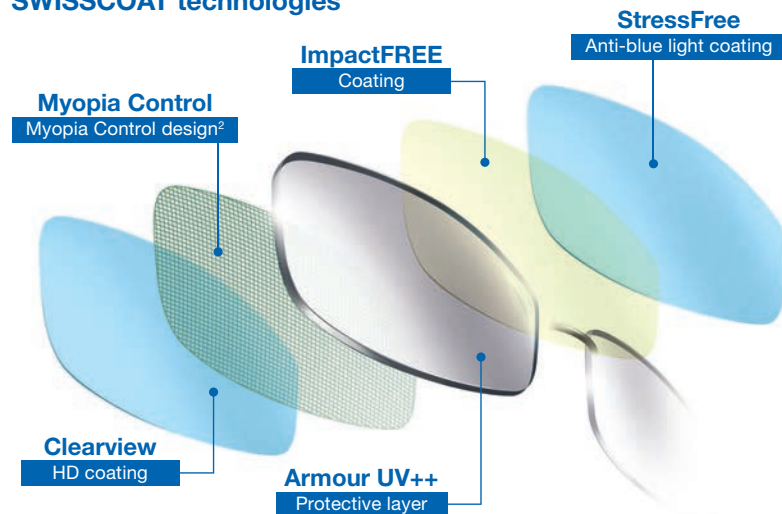

## StressFree - the blue light protection proven by The Hong Kong Polytechnic University

Hong Kong is a city that is drenched in blue light. With flashy monitors everywhere and the ever increasing usage of electronics such as smartphones, their eyes are susceptible to more blue light than most other cities, and could drastically affect their eye health.

There is a way to stem the tide. With SWISSCOAT’s StressFree coating features effective protection against high energy blue light. In a commissioned research done by The Hong Kong Polytechnic University<sup>1</sup>, it is proven that SWISSCOAT’s StressFree coating offers the following benefits.

1. Effectively filters high energy blue light
2. Does not hinder color and contrast sensitivity
3. Does not affect night vision

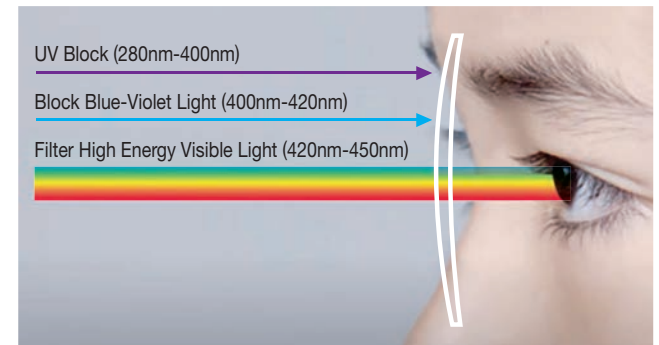

1. Reported by The Hong Kong Polytechnic University in the January 3rd 2017 publication from PLoS ONE. 2. Progression of Myopia in Hong Kong Chinese Schoolchildren Is Slowed by Wearing Progressive Lenses, Optom Vis Sci 1999;76:346-354

# Kids ProTECH ADVANTAGES

- 1 Relieve the lengthening of ocular axis
- 2 Correct Myopia
- 3 Comfortable
- 4 Suitable for Myopia wearer that from 6 to 16 years old

## Fitting Tips

- 1 Same as progressive lens

# MYO Protech

## Know More About Peripheral Defocus Lenses!



- From the extensive work of Smith et al.,<sup>4-6</sup> we have been convinced that relative peripheral hyperopia stimulates the eye to increase in axial length.

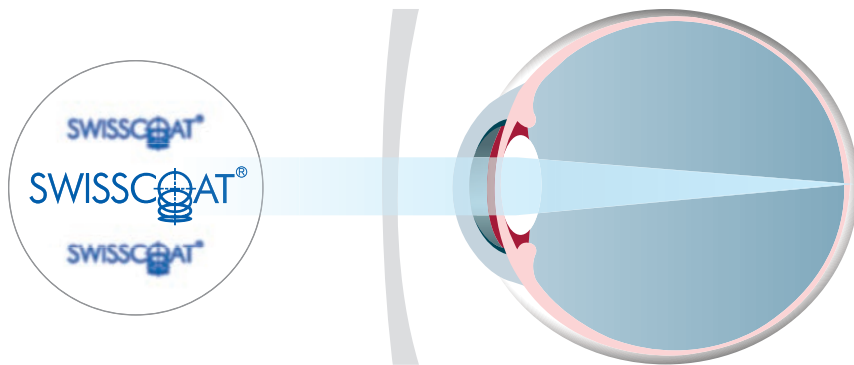

- Eyeball extending as Myopia power increasing.
- Higher Correction error on higher power.

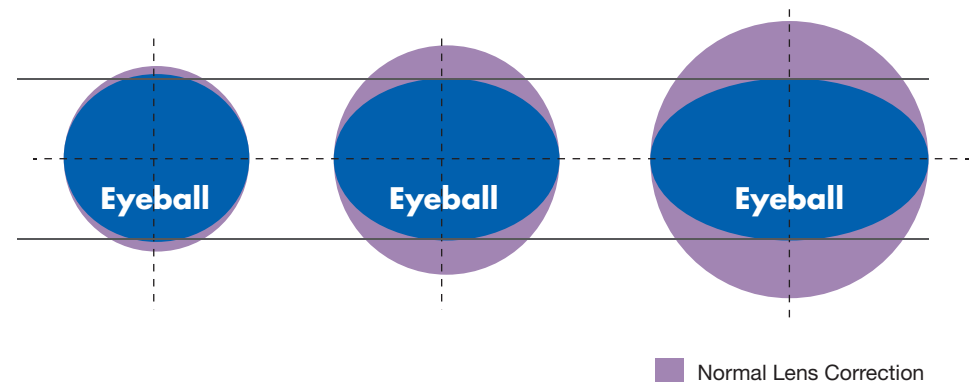



- SWISSCOAT Myopia Monitoring provide different correction curve to minimize the over correction.

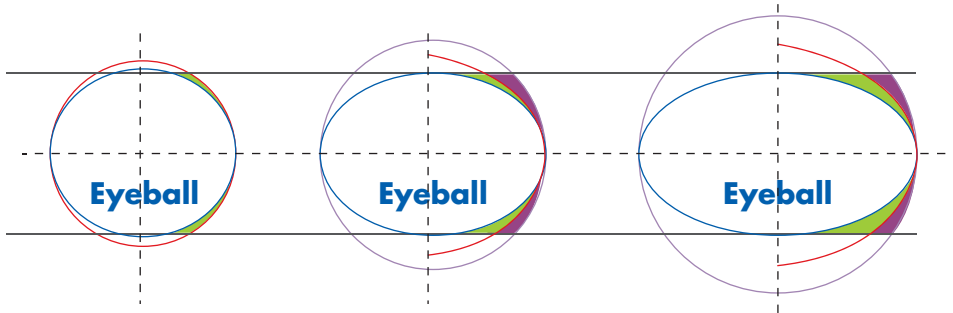

- 3mm distance zone for normal correction. Minus power decreasing to the edge with different slope design.
- Keep the distance power extend to the near vision zone for reading.

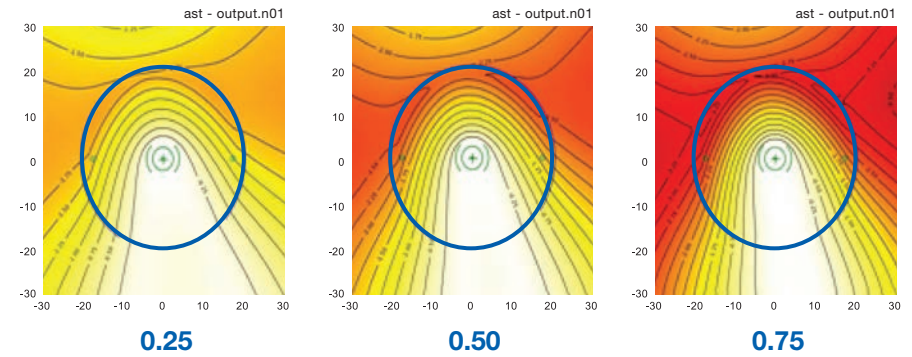

## MYO PROTECH DESIGN PRINCIPLE

1. Aspherical
2. Clear Vision on center part
3. Correcting defocus from optical center to periphery
4. Far Distance power is extended to reading zone at the lower part of the lens with inset
5. Defocus option available in 0.25, 0.50, 0.75 step to 30mm



Each MYO Protech lens is infused with 5 major SWISSCOAT technologies:

- StressFree Anti-blue light coating
- Myopia Control design
- Armour UV++ protective lens
- ImpactFREE coating
- Clearview HD coating

## Each Kids MYO Protech lens is infused with 5 major SWISSCOAT technologies

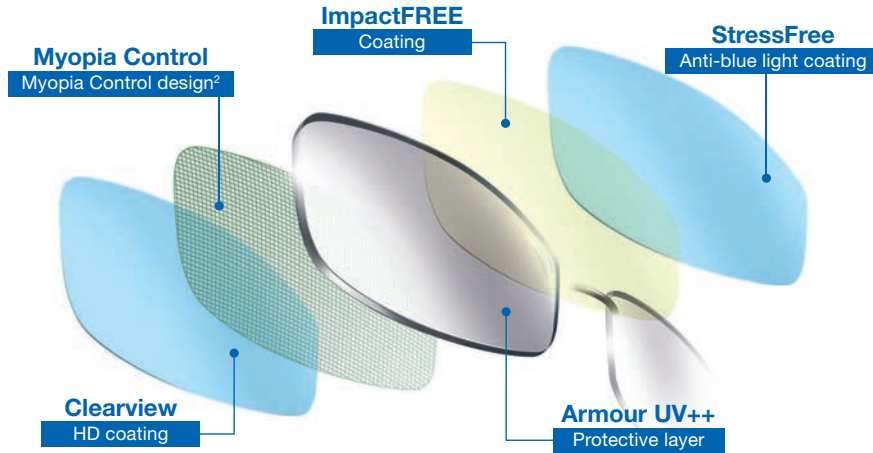

### StressFree - the blue light protection proven by The Hong Kong Polytechnic University

Hong Kong is a city that is drenched in blue light. With flashy monitors everywhere and the ever increasing usage of electronics such as smartphones, their eyes are susceptible to more blue light than most other cities, and could drastically affect their eye health.

There is a way to stem the tide. With SWISSCOAT's StressFree coating features effective protection against high energy blue light. In a commissioned research done by The Hong Kong Polytechnic University<sup>1</sup>, it is proven that SWISSCOAT's StressFree coating offers the following benefits.

1. Effectively filters high energy blue light
2. Does not hinder color and contrast sensitivity
3. Does not affect night vision

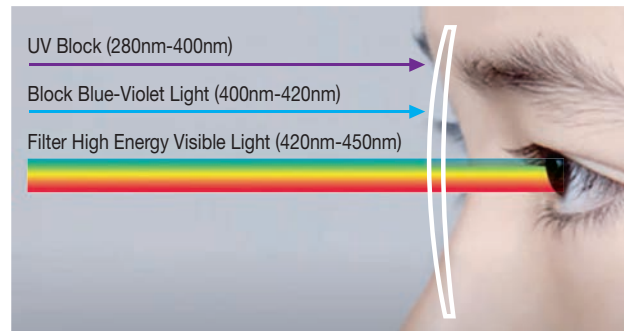

## Engraving Chart

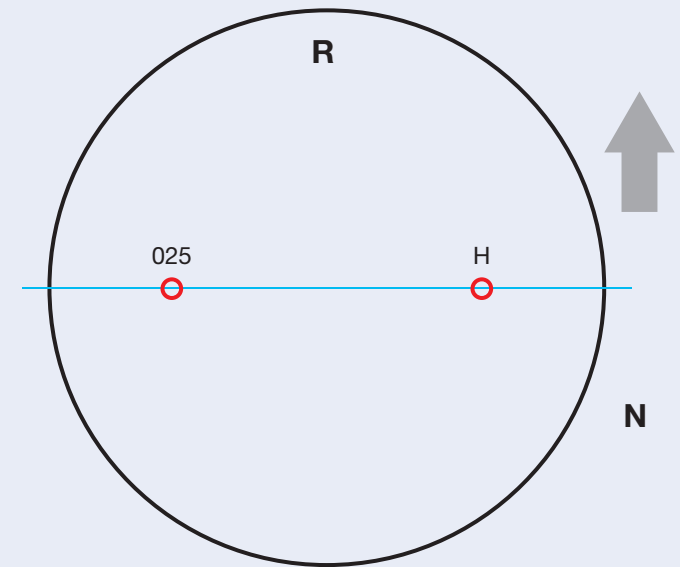

H = Material Code  
025 = Design Code

1. Reported by The Hong Kong Polytechnic University in the January 3rd 2017 publication from PLoS ONE. 2. Progression of Myopia in Hong Kong Chinese Schoolchildren Is Slowed by Wearing Progressive Lenses, Optom Vis Sci 1999;76:346-354

# MYO Protech ADVANTAGES

- 1 Relieve the lengthening of ocular axis
- 2 Correct Myopia
- 3 Comfortable
- 4 Suitable for Myopia wearer that from 6 to 16 years old

## Fitting Tips

- 1 Same as progressive lens
- 2 Fitting height required
- 3 Mono PD required
- 4 Keep the pupil position at least 15mm to the rim of nasal
- 5 PD difference from frame PD to client PD within 5mm
- 6 Max power for 025 design: -2.00D (Over -2.00D)
- 7 Max power for 050 design: -3.00D (Over -2.50D)
- 8 Max power for 075 design: -4.00D (Over -3.00D)

# SPORT

iAction · iAction™

# iAction

## Perfect Vision for Active and Sports Wearer



SWISSCOAT iAction is ideal for all types of sports and outdoor activities. It is a unique single vision and progressive lens developed for a wide variety of wrap-around frames. It protects eyes while effectively expanding vision zone and enhancing peripheral vision. With SWISSCOAT iAction you benefit from a design breakthrough: the creation of single base curve that doesn't compromise on optical quality and is suitable for extensive range of prescriptions.

### Spherical Aberration

A perfect lens focuses all incoming rays to a point on the optical axis. A real lens with spherical surfaces suffers from spherical aberration: it focuses rays more tightly if they enter it far from the optical axis than if they enter closer to the axis. It therefore does not produce a perfect focal point. (drawing is exaggerated)

Refer to: [https://en.wikipedia.org/wiki/Spherical\\_aberration](https://en.wikipedia.org/wiki/Spherical_aberration)

In order to solve the spherical aberration, aspheric lens is made to offset the spherical aberration by applying various curvature on the lens surface. The curvature will be flatter toward the edge of the lens. The aspheric lens is not only with clear image and also with flatter and thinner results.

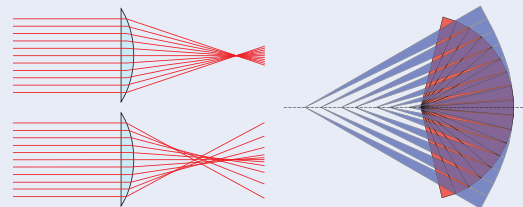

### Prism Effect of Warp-Around Frame

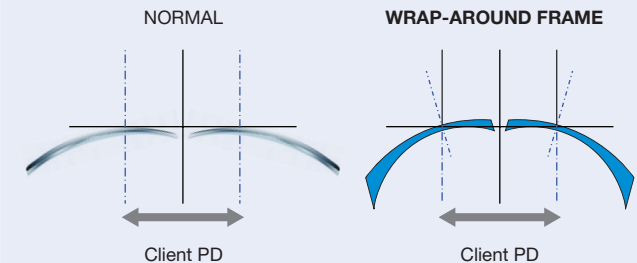

# iAction ADVANTAGES

- 1 Minimize the uncomfortable prismatic effect
- 2 Mild optical deviation

## Fitting Tips

- 1 Subject to material, lens diameter up to 85mm
- 2 Front base curve: +6.00/+7.00/+8.00
- 3 Single Vision and Progressive available
- 4 Single vision fitting: At the center of marking
- 5 Progressive fitting: 4mm above center of engraving axis
- 6 Progressive minimum fitting height: 15mm - 18mm
- 7 Variable inset available

# iAction™

## The Next Level of Sport Prescription Lenses



NEW iAction™, the most advanced sport prescription lenses program, the lenses are produced individually to maximize a full field of view and prevent distortion. Ordinary Prescription lenses can be heavy and thick, iAction™ apply an entire new lens technology, thickness is then reduced by up to 40% for a comfortably lighter lens; peripheral vision is optimized, guaranteeing 120 degree of binocular visual field.

- COMPLETE BINOCULAR VISION
- ENSURES FUSION OF IMAGES
- BETTER VISUAL COORDINATION

\*Our analysis indicates the angle of 120° as the ideal. Possibility to customize.

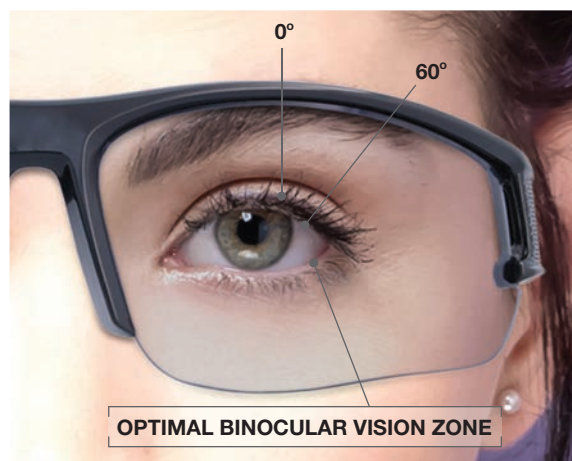

# iAction™



**Optimized Peripheral Vision**  
Guaranteeing 120° of binocular visual field



**Comfort**  
Distortion at the side is truly minimized and the vision performance is fully maximized



**Thinner Lenses up to 40%**  
Both positive and negative with maximum reduction of thicknesses



**Prescription Range**  
Extends to +4.00 to -7.00



Ordinary Sport Prescription lenses can be heavy and thick. Now thickness is reduced by up to 40% for a much lighter and thinner lens.



Distortion at the side is truly minimized and the vision performance is fully maximized.

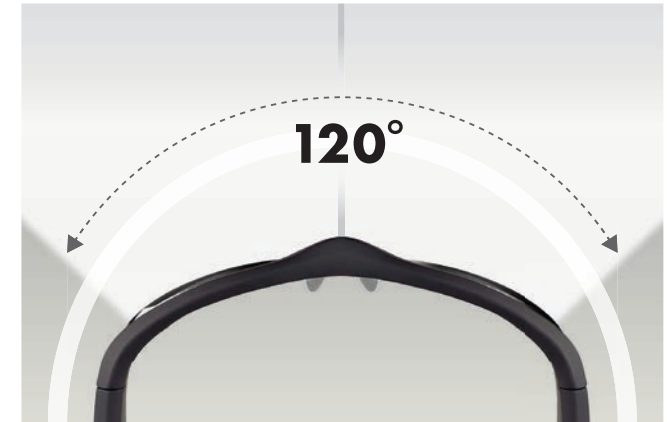

Optimized peripheral vision, guaranteeing minimum 120 field of view.

**PRESCRIPTION POWER**  
**+4.00 TO -4.00**

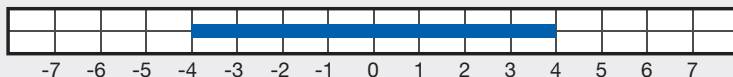

**PRESCRIPTION RANGE EXTENDS TO**  
**+6.00 TO -7.00**

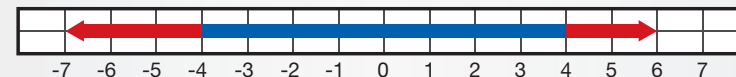



# iAction™ ADVANTAGES

- 1 Optimized peripheral, the best visual solution
- 2 Comfortable
- 3 Maximum reduction of thickness
- 4 Extend power range
- 5 Personalization

## Fitting Tips

- 1 Subject to material, lens diameter up to 85mm
- 2 Front base curve: +6.00/+7.00/+8.00
- 3 Single Vision and Progressive available
- 4 Single vision fitting: At the center of marking
- 5 Progressive fitting: 4mm above center of engraving axis
- 6 Progressive minimum fitting height: 16mm - 18mm
- 7 Variable inset available



# BIFOCAL

Flat-Top • Curve-Top • Kry-Top • Young Bifocal • Digital Seamless

# Flat-Top • Curve-Top • Kry-Top • Young Bifocal

**Keep Your Vision  
Comfortable for Every Day**



Bifocal Lenses are eyeglasses designed for people who need both near and far vision. Different from single vision lenses, bifocals have two vision, the upper part of the lens is used for far distance and the lower half of the lenses helps in reading or doing other close work.

SWISSCOAT offers 4 kinds of bifocal lenses for people needing different prescriptions for distance and near.

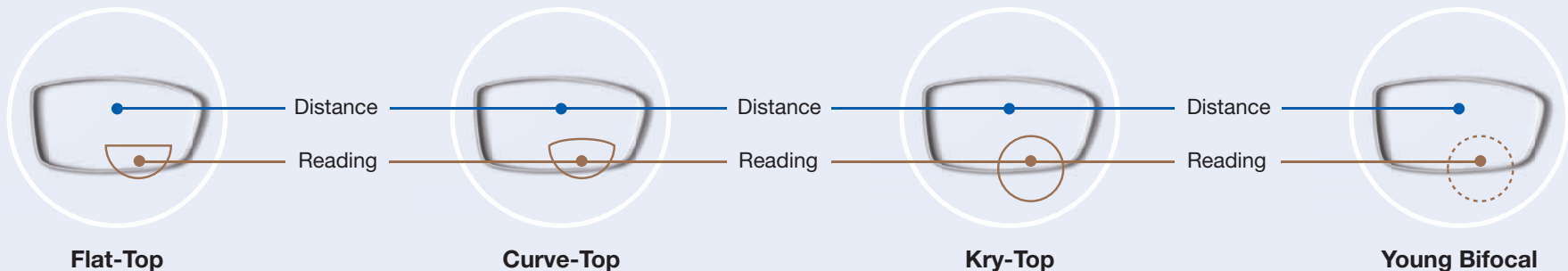

# Digital Seamless

## Bifocal Wearers

Digital Seamless is the ideal solution for bifocal wearers who are reluctant of progressive lenses.



Aesthetics and comfort in the new generation of bifocals, SWISSCOAT is offering a digital bifocal solution with 2 areas of vision for far and near vision respectively and a smooth and invisible transition area.

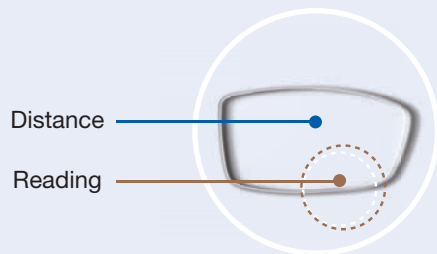

**Digital Seamless**



**Personalized Lens**  
Personalized lens considering the position of wear



**Visual Comfort**  
Minimized image jump



**Aesthetics**  
Improved aesthetics as it eliminates the visible dividing line

# ADVANTAGES

- 1 Extended near and intermediate vision zone
- 2 Available in various indexes and lens material

## Fitting Tips

- 1 Fitting cross: Center point of engraving axis
- 2 Minimum vertical frame size: 26mm
- 3 Fitting height: 16mm
- 4 Minimum 10mm from the fitting cross to the top of the inner frame
- 5 Ordering with progressive prescription

A woman with blonde hair and black-rimmed glasses is sitting at a desk, looking at a laptop. She is wearing a light-colored, textured sweater over a striped collared shirt. A pink mug is visible in the foreground. The background is a blurred office environment with green plants.

# THE INDOOR

Conventional Office • Precision Office • iRoom • iOffice • iReader

# Conventional Office

SWISSCOAT Conventional Office is created to the wearers who work long time in an office and in front of a computer; it is an ideal lens for alleviating computer vision syndrome and the alternative to reading glasses. Conventional office - visual range of 1.3ft (40cm) to 10ft (3m).

## SWISSCOAT Office Power Range

<b>Lens Type</b>	A75	A125	A175	A225
<b>Far to near vision</b>	0.75D	1.25D	1.75D	2.25D
<b>Far to middle vision</b>	0.25D	0.50D	0.75D	0.75D
<b>Middle to near version</b>	0.50D	0.75D	1.00D	1.50D

### Unlimited Computer Vision

● Clear Vision ● Unclear Vision

## Recommended Dynamic Power for Maximum Distance Vision

Patients Reading Add	Office Dynamic Power							
	-0.75(D)		-1.25(D)		-1.75(D)		-2.25(D)	
	Feet	Meter	Feet	Meter	Feet	Meter	Feet	Meter
0.75	Infinity							
1.00	13.20	4.00	Feet	Meter				
1.25	6.60	2.00	Infinity					
1.50			13.20	4.00	Feet	Meter		
1.75			6.60	2.00	Infinity			
2.00					13.20	4.00	Feet	Meter
2.25					6.60	2.00	Infinity	
2.50					*5.00	*1.50	13.20	4.00
2.75					*3.30	*1.00	6.60	2.00
3.00					*2.70	*0.80	5.00	1.50
3.25							3.30	1.00
3.50							2.70	0.80

\*Relevant only for Glass which is not available in DP-2.25 [D].

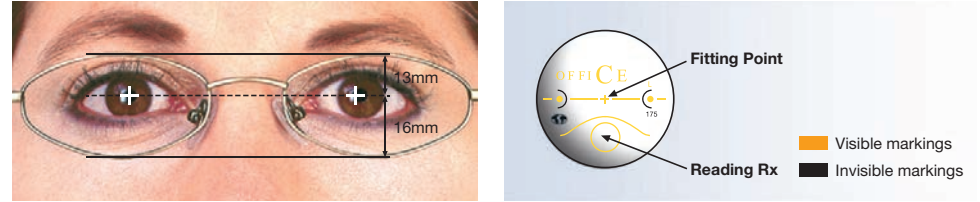

Conventional Office	Technical Specification	
<b>Index</b>	1.5	1.5
<b>Material</b>	Clear	Clear
<b>Max Diameter (mm)</b>	75+5	75+5
<b>Reading power range</b>	+6.50D ~ -6.50D	+6.50D ~ -3.00D
<b>Dynamic Power range</b>	A0.75/A1.25/A1.75	A2.25
<b>Fitting Height</b>	16mm	16mm
<b>Color Tinting</b>	Yes	Yes

Any power exceeds the power range, contact SWISSCOAT customer service officer.

# Conventional Office ADVANTAGES

- 1 Extended near and intermediate vision zone
- 2 Available in various indexes and lens material

## Fitting Tips

- 1 Fitting cross: Center point of engraving axis
- 2 Minimum vertical frame size: 26mm
- 3 Fitting height: 16mm
- 4 Minimum 10mm from the fitting cross to the top of the inner frame
- 5 Ordering with progressive prescription



# Precision Office

## The Best Vision for All Distances



A Precision engineered desk work progressive lens, Precision Office is ideal for your desk work. It is an unique lens design which offers you more freedom of movement in the office. This design has extremely wide near, intermediate zone and the clear vision field. They are the best choice for the wearer when working with computers, at work, at home and at play.

### Multi-screen environment

The multi-screen environment will affect the human visual system, resulting in intraocular pressure and reducing our visual performance.

Precision office is a solution for multi-screen environments. With its sleek design, Precision office can provide the visual clarity required for every task.

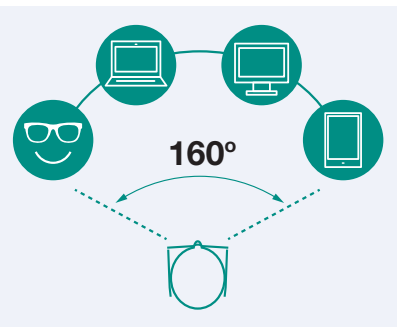

### Ordering with full prescription; Distance power and additional power

**Fitting point:**  
Center of two invisible engraving  $\left[ \begin{array}{c} \square \\ 25 \end{array} \right] \left[ \begin{array}{c} \square \\ E \end{array} \right]$

#### Inspection of lens:

- Inspection of Intermediate power at 8mm above fitting point
- Inspection of reading power at 16mm below center of engraving with 2.5mm insert
- Vision distance:  
Working distance for reading: 40cm  
Intermediate working distance:
- Additional power less than 1.25D (0.75D to 1.00D); vision distance up to around 2m
- Additional power over or equal to 1.25D; vision distance up to around 1.3m

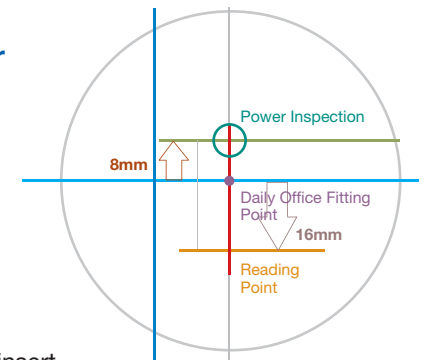

# Precision Office ADVANTAGES

- 1 Extended near and intermediate vision zone
- 2 Available in various indexes and lens material

## Fitting Tips

- 1 Fitting cross: Center point of engraving axis
- 2 Minimum vertical frame size: 26mm
- 3 Fitting height: 16mm
- 4 Minimum 10mm from the fitting cross to the top of the inner frame
- 5 Ordering with progressive prescription

# iRoom · iOffice · iReader

iRoom, iOffice and iReader are office Reading glasses. The degressive power will be automatically calculated by program, this is a real individual near-vision lenses that guarantee you optimum comfort in wear. The working zone of each category varies, the actual distance of the working zone depends very much on the addition power and result of the program calculation.

Each pair of lenses is automatically calculated by the sophisticated Precision Office program. This is a truly personalized mid-near-specific lens that can ensure you get the best comfort when wearing it. Each type of work area is different, the actual distance of the work area depends largely on the results of the program calculations.

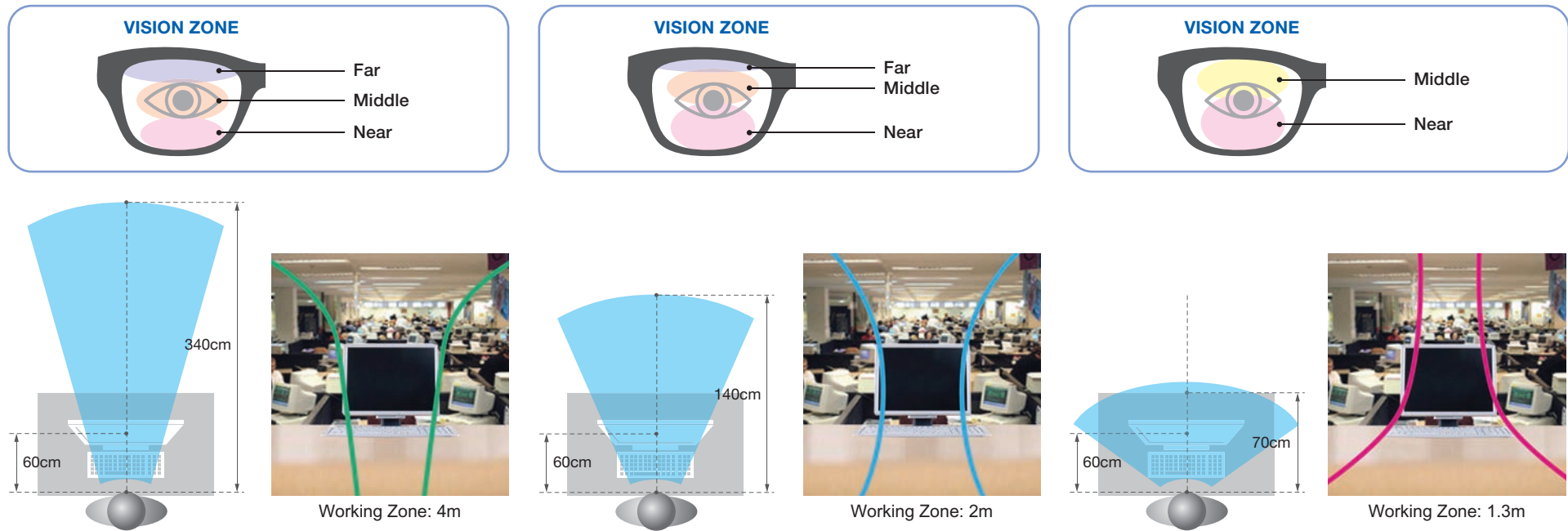

**iRoom (40cm - 400cm)**

Suitable for office people, or people who often stay indoors.

Vision (Depth): ●●●●○

Vision (Width): ●●●○○

**iOffice (40cm - 200cm)**

Suitable for people always stay indoor or office people, or people who often use computers, watch mobile phones or tablets.

Vision (Depth): ●●●○○

Vision (Width): ●●●●○

**iReader (40cm - 130cm)**

Suitable for people always handle paper works and often use computers, watch mobile phones or tablets.

Vision (Depth): ●●○○○○

Vision (Width): ●●●●●

# iRoom · iOffice · iReader ADVANTAGES

- 1 Extended near and intermediate vision zone
- 2 Customized with intermediate working distance
- 3 Available in various indexes and lens material

## Fitting Tips

- 1 Fitting cross: Center point of engraving axis
- 2 Minimum vertical frame size: 26mm
- 3 Fitting height: 16mm
- 4 Minimum 10mm from the fitting cross to the top of the inner frame
- 5 Ordering with progressive prescription
- 6 Degression power automatically be calculated by program
- 7 Choice for intermediate vision distance: from 65cm to 4m (5cm per step) on eye level



# PROGRESSIVE

Conventional • High Definition • Precision • *My World* • Smart Evolution

# Progressive Lenses

All SWISSCOAT Progressive lenses are true “multifocal” lenses that provide a smooth, seamless progression of many lens powers for clear vision across the room, up close and all distances in between.

When switching vision zones, the final user no longer has a feeling of falling or being out of control. For advanced progressive lens models, despite widened vision zones, distortional levels are reduced while lower prismatic levels allow for a thinner lens in all directions.

With progressive lenses, vision levels are improved and so is the elegant appearance of the lens when compare with bifocal lenses.

## Precise Focus and Clarity Wherever You Look

Progressive lenses create a brand new experience for wearers, making it easier to focus on the project and hand. Whether you’re at work on the computer or reading on the train, these glasses provide unrivalled clarity. Conventional progressive lenses just don’t compare.

If you’re curious about the quality of SWISSCOAT’s progressive lenses, be sure to contact our team. We aim to provide better vision for all our customers, through regular treatment, innovative and superior lenses and exceptional guidance and advice.

## Order Your New Innovative Progressive Glasses Today

SWISSCOAT new advanced design progressive lens comes with Precision, My World and Smart Evolution, to experience the whole new ultra-wide near and far vision zone. Perfectly fitted to all wearer, these lenses are tailor-made just for you, ensuring greater wearer tolerance, faster adaptation and all-around clear vision.

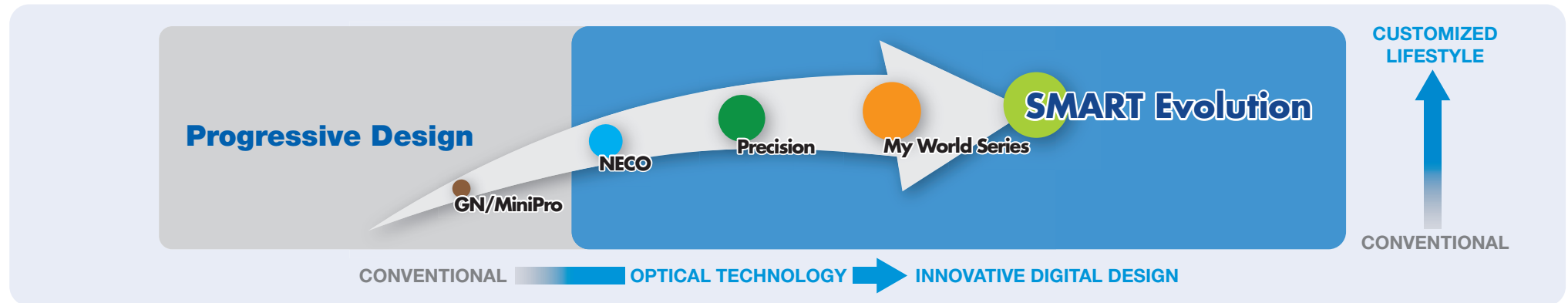

Conventional



Precision



My World



Smart Evolution

# Conventional Progressive



SWISSCOAT MiniPro Progressive lenses is the ultimate precision-engineered, short corridor progressive lenses for accurate, it is created for the fashionable eyeglasses wearers who do not want to compromise on style and quality.

SWISSCOAT MiniPro is a perfect soft, short corridor progressive lens on the market, enabling an easy transition between the far vision zone and the reading zone.

## MiniPro ADVANTAGES

- 1 Fits into small frames
- 2 Perfect binocular vision
- 3 Short corridor

### Fitting Tips

- 1 Fitting height of 16mm
- 2 Aspheric in all vision zone

# Conventional Progressive



SWISSCOAT Genius, an advanced eye-point technology designed progressive lenses. The sophisticated technology takes into account of numerous parameters:

- Lens index refraction
- Lens prescription
- Lens center thickness
- Distance from the eye to the back vertex of the lens
- Distance from the lens to the object
- Object's angular position in the eye's field of vision
- Pantoscopic tilt of the frame
- Pupil distance
- Thickness reduction prism

## Genius ADVANTAGES

- 1 Improved peripheral vision because it is designed through an exact simulation of the eye
- 2 Guarantee perfect binocular vision, enabling patients to clearly perceive an object's depth and dimension
- 3 Bringing vision clarity to an optimal level in every vision zone
- 4 Soft design for every vision zone
- 5 Aspheric in all its vision zone, the thinnest possible lens

### Fitting Tips

- 1 Fitting height of 19mm
- 2 Aspheric in all vision zone

SWISSCOAT Genius is the ultimate precision - engineered progressive lens for accurate, individualized design for every angle, every vision zone and every prescription. Your patients will immediately sense the difference because of the following benefits:

- Surround Vision** : SWISSCOAT Genius ensures improved Vision because it is designed though an exact simulation of the eye.
- Prism Balance** : SWISSCOAT Genius guarantees perfect Binocular Vision, enabling patients to clearly perceive an object's depth and dimension. Super Clarity.
- Super Clarity** : SWISSCOAT is based on SWISSCOAT's advanced Eye-Point Technology, vision clarity is enhanced even more, bringing it an optimal level in every vision zone.
- Soft Design** : A technological breakthrough, SWISSCOAT's Eye-Point Technology ensures the softest lens design for every vision zone.
- Pure Asphericity** : Aspheric in all its vision zones, SWISSCOAT Genius is the thinnest possible lens.
- Perfect Adaptation to all Frames Sizes** : SWISSCOAT Genius is designed for a variety of frame sizes - small and large alike.

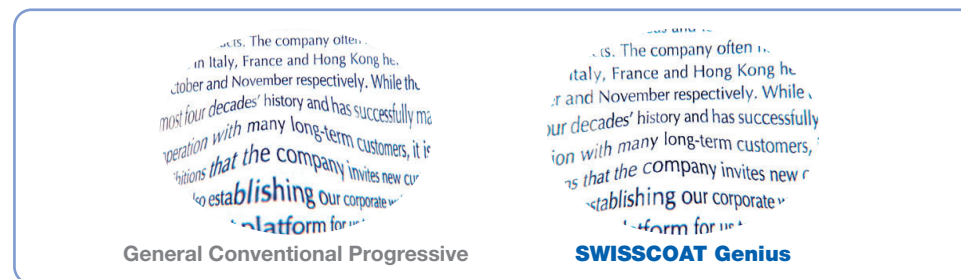



# High Definition Progressive



A Powerful entry level progressive lenses. Easy design takes visual needs of presbyopia who use handheld devices daily into account.

## Visual Quality within your reach

NECO Progressive lens design is the result of applying innovative optimization techniques to standard progressives. Both of the progressive enhanced visual quality with clean areas and smooth gradients.

## NECO ADVANTAGES

- 1 Budget progressive
- 2 Perfect fit for progressive beginners

## Fitting Tips

- 1 Fitting height of 17mm
- 2 Power compensation: NO

# Precision Progressive the New Personalized Progressive Lens

SWISSCOAT Precision Progressive lens series was originated in 2007, a back-side freeform progressive lens. The Precision series offers two models: Daily and Sport, a well-reputed lens series has been highly recommended by the users after its launch. Users are highly satisfied with the Precision's visual performance.

Precision Advance is the finest design of Precision progressive series whereas providing wider distance and near vision, and stable intermediate vision. Adding visual distortion softening technology - harmonizer, effectively flattens the edges of the distortion upto 40%, compared with the general conventional progressive lens while offering wider, more comfortable vision. Precision Advance is designed for any progressive lens users perceiving superior visual comfortable vision.

The left and right distortion of the general conventional progressive lens and the basic back-side free form progressive lens are fixed while distortion depends on the magnitude of near addition power.

As for cases of higher near addition power, the left and right bottoms of a lens are clearly distorted, resulting in intermediate visual oppression and discomfort.

Power: Sph:0.00 Add: +2.00 (Right Eye)

**CYLINDER MAP**

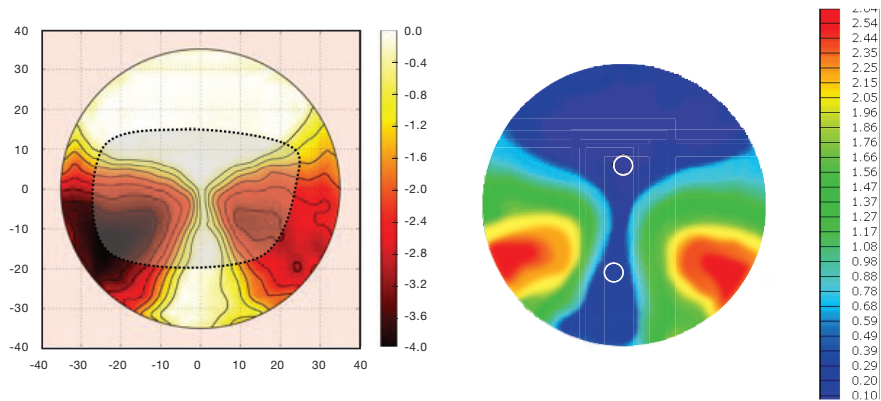

**General Conventional Progressive**

\*distortion of a conventional progressive lens

Harmonizer – Visual Distortion Softening Technique: Take a frame shape and size into consideration, resonate distortion with a lens' outside area in order to reduce distortion on both sides and enhance overall visual width and comfortability in the distance vision.

Power: Sph:0.00 Add: +2.00 (Right Eye)

**CYLINDER MAP**

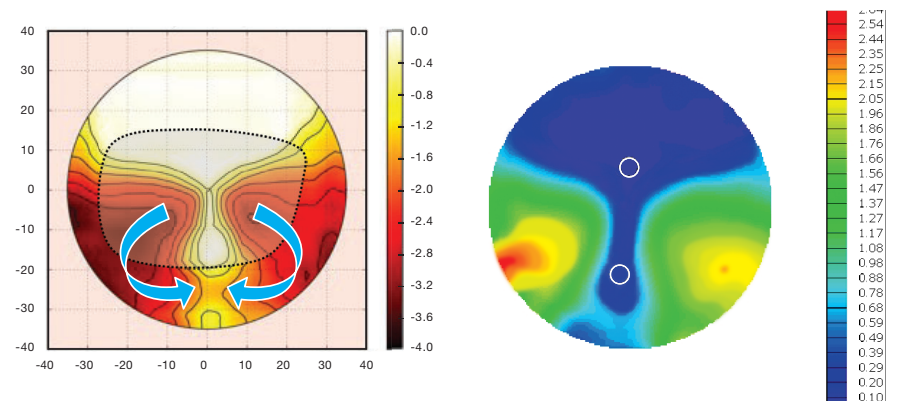

**Precision Advance**

\*reduced distortion after applying Harmonizer technique



Conventional Progressive Lens Simulation



Precision Advance Simulation

The new **SWISSCOAT Precision Advance Personalized Progressive Lens** is designed for advanced users demanding balanced distance and near vision.

- Reduce optical aberration in both left and right distortion zone by a horizontally balanced distortion design
- Provide wider, more stable distance and reading vision after bending distortion away from lens shape

### Precision Series Function Comparison Chart

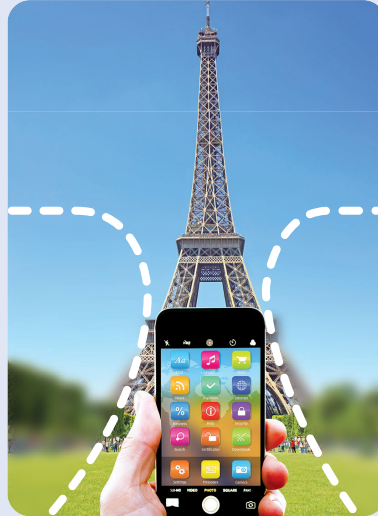

Precision Advance

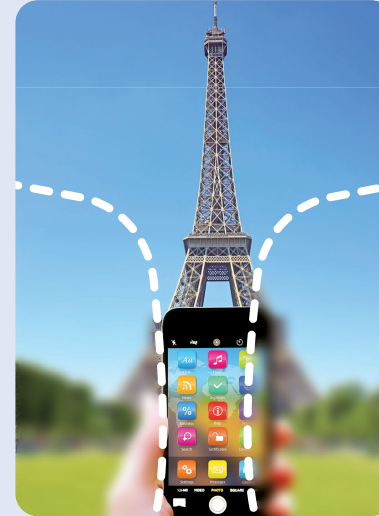

Precision Daily

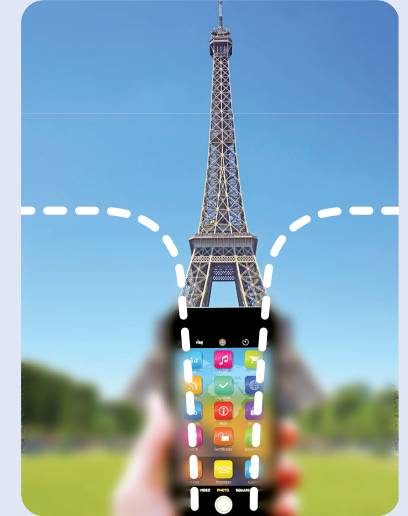

Precision Sport

	Precision Advance	Precision Daily	Precision Sport
Distance Vision	★★★★★☆☆	★★★★★☆☆	★★★★★☆☆
Intermediate Vision	★★★★★☆☆	★★★★★☆☆	★★★★★☆☆
Near Vision	★★★★★☆☆	★★★★★☆☆	★★★★★☆☆
Lens stability on both sides	★★★★★☆☆	★★★★★☆☆	★★★★★☆☆
Wearing comfort	★★★★★☆☆	★★★★★☆☆	★★★★★☆☆

# Precision ADVANTAGES

- 1 Fit to all optical frames
- 2 Reduce optical abbreviation
- 3 Wider and more stable distance and reading vision after bending distortion away from lens shape

## Fitting Tips

- 1 Fitting height: 15 to 19mm
- 2 Near inset: Available
- 3 Pantoscopic tilt: Optional
- 4 Wrapping angle: Optional
- 5 Back vertex distance: Optional
- 6 Pupil distance: Required
- 7 Power compensation: NO
- 8 Fitting Cross at MRP

## SWISSCOAT Technical Specification Plastic

Precision						
Index	1.5	1.53	1.59	1.61	1.67	1.74
<b>Material</b>	Clear SunAdapt XTRActive Transitions Gen8 Nupolar Drivewear	Clear NXT XTRActive Transitions Gen8	Clear Transitions Gen8 Drivewear	Clear Armour UV++ Armour Sun UV++ SunAdapt XTRActive Transitions Gen8 Nupolar	Clear Armour UV++ Armour Sun UV++ SunAdapt XTRActive Transitions Gen8 Nupolar	Clear Armour UV++ *Armour Sun UV++ Transitions Gen8
<b>Max Diameter</b>	75+5	75+5	75+5	75+5	75+5	75+5
<b>Fitting Height</b>	15mm to 19mm	15mm to 19mm	15mm to 19mm	15mm to 19mm	15mm to 19mm	15mm to 19mm
<b>Rx Power Range</b>	+6.00 ~ -8.00	+6.00 ~ -8.00	+6.00 ~ -9.00	+8.00 ~ -10.00	+8.00 ~ -11.00	+7.00~ -12.00
<b>Addition Power</b>	A+0.75 ~ A+3.50	A+0.75 ~ A+3.50	A+0.75 ~ A+3.50	A+0.75 ~ A+3.50	A+0.75 ~ A+3.50	A+0.75 ~ A+3.50
<b>Power Compensation</b>	YES	YES	YES	YES	YES	YES

Any power exceeds the power range, contact SWISSCOAT customer service officer.

\* 1.74 Armour Sun UV++ **Coming Soon**

# My World Progressive



## iFree Build Your Unique Progressive Lens with MyWorld Digital Lens Technology

Your ideal personalized progressive lens, iFree progressive design contains unique information to produce a fully personalized progressive lens. iFree lens series is a family of lenses incorporating Digital Ray Path technology. Ultimate lenses offer sophisticated technology and advanced optical performance.

**iFree Advance** is a fully personalized design with a balance between distance and near vision. It is highly recommended for experienced and demanding wearers who are looking for an all-purpose, comfortable progressive lens with wider visual fields at all distance.



**iFree Mobile**  
Designed exclusively for electronic device users.

**iFree Soft**  
Perfect balance between distance and near visual fields.

Progressive Models	Graphic Simulation	Features	Remarks
<b>iFree Advance</b>		Far: ★★★★★ Near: ★★★★★ Mobile vision: ★★★☆☆ Comfort: ★★★★★	<ul style="list-style-type: none"> <li>Balanced type</li> <li>Hard design for advanced users</li> </ul>
<b>iFree Mobile</b>		Far: ★★★★★ Near: ★★★★★ Mobile vision: ★★★★★ Comfort: ★★★★★	<ul style="list-style-type: none"> <li>Balanced type</li> <li>Hard design modified for frequent usage of mobile devices</li> </ul>
<b>iFree Soft</b>		Far: ★★★★★ Near: ★★★★★ Mobile vision: ★★★★★ Comfort: ★★★★★	<ul style="list-style-type: none"> <li>Balanced type</li> <li>Super soft design; very easy adaptation</li> </ul>

# iFree ADVANTAGES

- 1 Fully customization
- 2 Lifestyle customization
- 3 Large field of view
- 4 Optimum vision and wearing comfort
- 5 Guarantee comfortable to wear

## Fitting Tips

- 1 Fitting height: 10 to 20mm
- 2 Near inset: Available
- 3 Pantoscopic tilt: Required
- 4 Wrapping angle: Required
- 5 Back vertex distance: Required
- 6 Pupil distance: Required
- 7 Power compensation: Optional
- 8 Fitting Cross above MRP 4mm

## SWISSCOAT Technical Specification Plastic

iFree						
Index	1.5	1.53	1.59	1.61	1.67	1.74
<b>Material</b>	Clear SunAdapt XTRActive Transitions Gen8 Nupolar Drivewear	Clear NXT XTRActive Transitions Gen8	Clear Transitions Gen8 Drivewear	Clear Armour UV++ Armour Sun UV++ SunAdapt XTRActive Transitions Gen8 Nupolar	Clear Armour UV++ Armour Sun UV++ SunAdapt XTRActive Transitions Gen8 Nupolar	Clear Armour UV++ *Armour Sun UV++ Transitions Gen8
<b>Max Diameter</b>	75+5	75+5	75+5	75+5	75+5	75+5
<b>Fitting Height</b>	10mm to 20mm	10mm to 20mm	10mm to 20mm	10mm to 20mm	10mm to 20mm	10mm to 20mm
<b>Rx Power Range</b>	+6.00 ~ -8.00	+6.00 ~ -8.00	+6.00 ~ -9.00	+8.00 ~ -10.00	+8.00 ~ -11.00	+7.00~ -12.00
<b>Addition Power</b>	A+0.75 ~ A+3.50	A+0.75 ~ A+3.50	A+0.75 ~ A+3.50	A+0.75 ~ A+3.50	A+0.75 ~ A+3.50	A+0.75 ~ A+3.50
<b>Power Compensation</b>	YES	YES	YES	YES	YES	YES

Any power exceeds the power range, contact SWISSCOAT customer service officer.

\* 1.74 Armour Sun UV++ Coming Soon

# Smart Evolution Progressive

Anyone into luxury visual comfort is sure to be impressed by the Smart Evolution 3D digital progressive. The design combines functionality with extraordinary style and suits for today's demanding customers.

High Definition Digital surfacing now enables the manufacturing of lenses with tremendous accuracy, ensuring lenses are produced to the designer's desire.

Each pair of Smart Evolution comes with a guaranteed level of quality and performance.



## Smart E 1.0 The Best Self Progressive Lenses

### ALL - IN - ONE

**A** Smart All Round

**L** Smart Learner

**N** Smart Mobile

**D** Smart Distant

## Lens Design Recommendation

Design	Model	Target Customer	Features			min FH (mm)
			Far	Near	Comfort	
Smart All - in - one	<b>A</b> TYPE ALL ROUND	Demanding Customers	★★★★★☆☆	★★★★★☆☆	★★★★★☆☆	14~20(1mm/step)
	<b>L</b> TYPE LEARNER	Novice wearers	★★★★★☆☆	★★★★★☆☆	★★★★★☆☆	16~20(1mm/step)
	<b>N</b> TYPE MOBILE	Wearers with intense use of near vision	★★★★★☆☆	★★★★★☆☆	★★★★★☆☆	14~20(1mm/step)
	<b>D</b> TYPE DISTANT	Outdoors wearers	★★★★★☆☆	★★★★★☆☆	★★★★★☆☆	14~20(1mm/step)

### **A** TYPE ALL ROUND

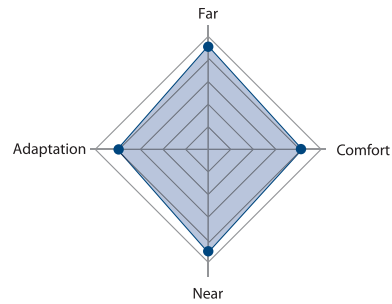
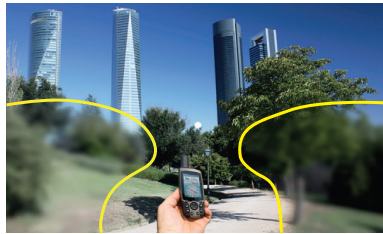

### **N** TYPE MOBILE

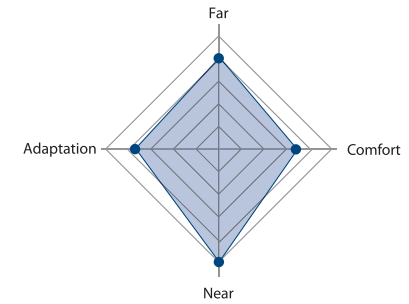

### **L** TYPE LEARNER

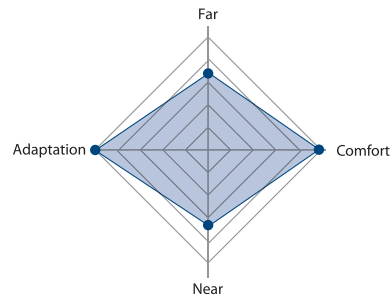
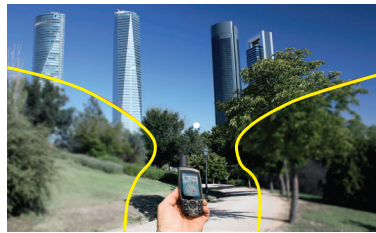

### **D** TYPE DISTANT

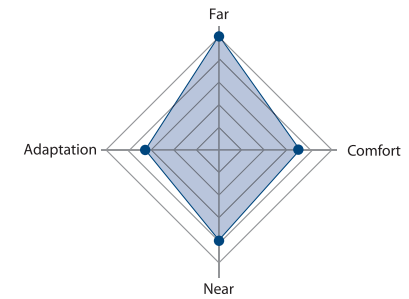



LAB BRAND™ DIGITAL LENSES WITH CAMBER™ TECHNOLOGY

## State-of-the-art digital lens design combined with sophisticated new lens blank technology

Smart Evolution 3D digital progressive lenses are now available with Camber Technology, representing a breakthrough in combining digital processing with an innovative new lens blank design. The specially designed Smart Evolution 3D digital progressive lens blank features a increasing base curve that provides the optically correct curvature in each zone of the lens. This allows expanded reading zones with improved peripheral vision. The advanced, digitally designed back surface can be comprehensively customized to each patient through a complete set of individualization parameters. Complex curves on both surfaces of the lens work together to provide excellent vision correction and a progressive lens experience like no other.

**camber**™  
**Availability**

Styles	Materials	Base Curves
Clear	Hard Resin	0.50, 2, 3, 4, 5, 6, 7, 8
Transitions® Signature™ Gray & Brown	1.60 High Index 1.67 High Index	

### Compare Front Surfaces

Most digital progressive lenses are processed from a single vision lens blank, which has just one base curve from top to bottom.

In this case, the base curve in the reading area is not ideal, and oblique astigmatism results.

The Camber lens blank has a patented, continuously increasing base curve, ideal for the increasing power profile of digital progressive lenses.

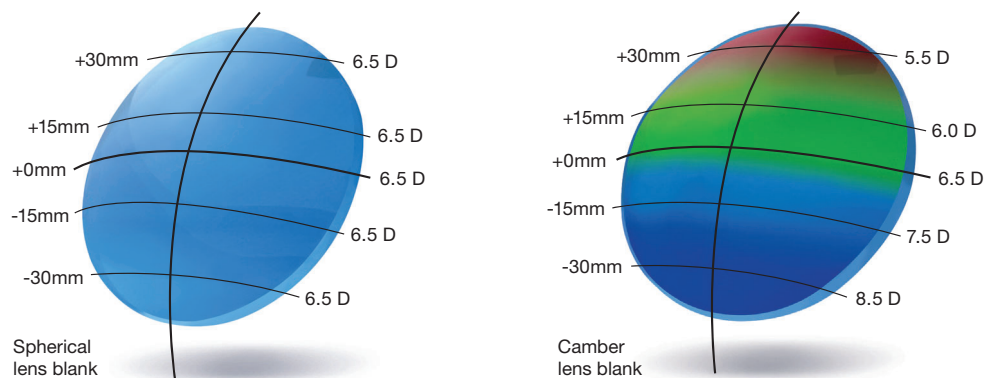

### A Combination of Complex Curves

When the unique front surface is combined with a sophisticated back-side digital design, both surfaces work together to become the Camber finished lens.

The design may be further enhanced by a complete set of individualization parameters to comprehensively customize the lens for each individual patient.

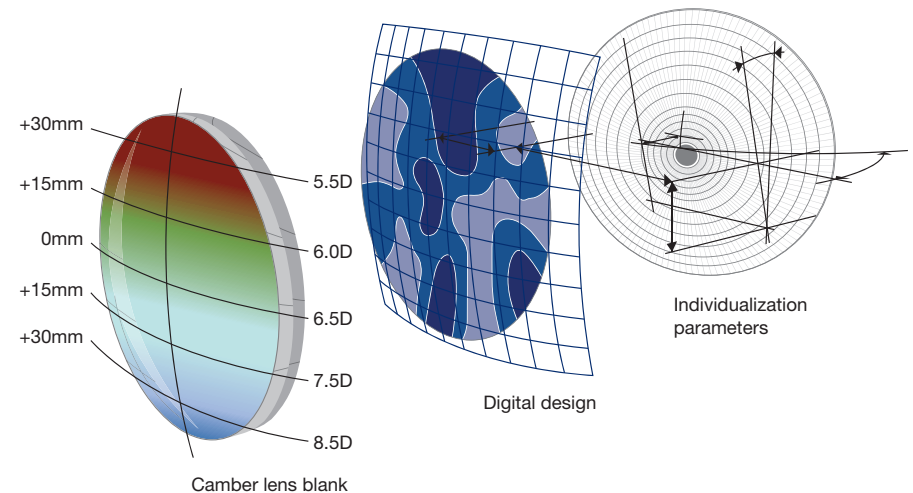

**The combination of the Camber variable base curve front surface and the enhanced digital back surface design creates the Camber finished lens, an advanced digital progressive that provides remarkable visual acuity in every viewing zone.**

Visit [CamberLens.com](http://CamberLens.com) for more information about Camber lens technology. Camber is a trademark and NuPolar is a registered trademark of Younger Mfg. Co. Transitions is a registered trademark and Signature is a trademark of Transitions Optical, Inc.

In a double-blind study, test wearers compared conventional single vision blanks with Camber blanks, each processed with same digital progressive design.

**STUDY PROCEDURE:**

- Test wearers wore each pair of glasses for the duration of one week, but were not aware of which lenses they were wearing for the entirety of the study.
- Both pairs of lenses were of identical material and base curve, and mounted in the same frame.
- Wearers were surveyed about their experience with the lenses after testing both.



TEST LENS **A**

[ PROCESSED FROM SINGLE VISION LENS BLANKS ]



TEST LENS **B**

[ PROCESSED FROM CAMBER LENS BLANKS ]

**“DOUBLE-BLIND” RESEARCH**  
To prevent bias, neither the wearers nor study administrators are aware of which lenses are being tried during either week.

**RESULTS OF WEARER STUDY**

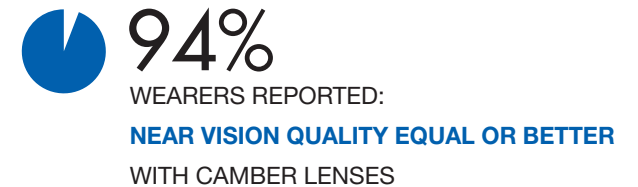
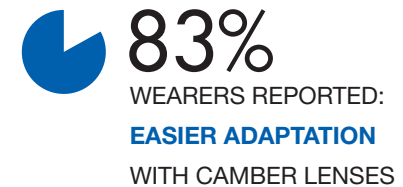

# HIERARCHY OF IMPORTANCE

**FOR MAKING A SUCCESSFUL PROGRESSIVE Rx**

There is lot of confusion in optical industry about which parameters are the most important towards supplying a successfully dispensed Rx progressive. Not surprisingly, those items directly controlled by the ECP are still the most important! Base curve and lens index material play a more important role than factors such as customization and individualization.

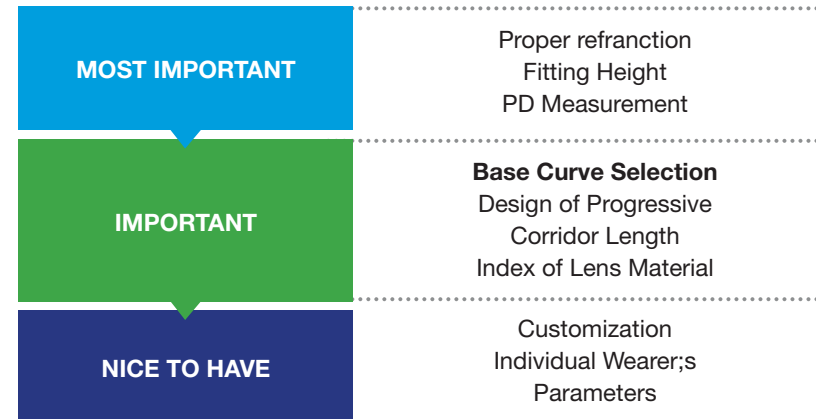

# Advanced Curve Technology for Progressive Rx Wearers

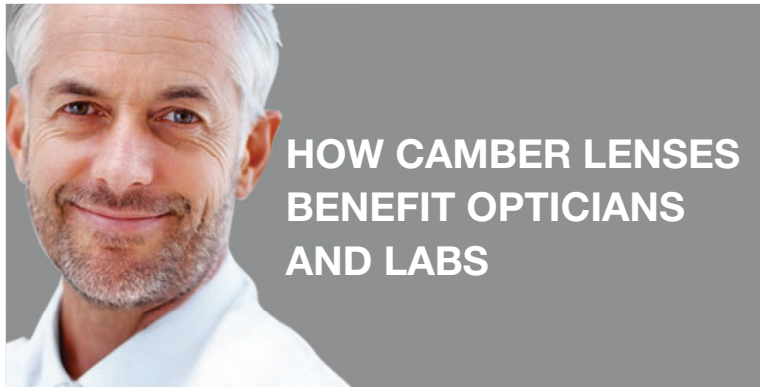

## HOW CAMBER LENSES BENEFIT OPTICIANS AND LABS

### SUPERIOR OPTICS

Wide open fields of vision

### PREMIUM TECHNOLOGY

Feel confident that the product you are dispensing is as technologically advanced as any lens in the market

### EASIER FRAME SELECTION

Higher base curve prescriptions have fewer frame limitations

### BETTER LOOKING

More cosmetically appealing front curve for many high plus and high add prescriptions



## HOW CAMBER LENSES BENEFIT PATIENTS

### BETTER VISION

In all zones, compared to SV Blank

### LATEST TECHNOLOGY

Camber's two-surface design is unique and patented

### FULLY CUSTOMIZABLE

Every variable that affects vision can be individualized to patient

### IMPROVED READING AREA

More spacious, easier to find with the eye

### EASIER ADAPTATION

Study shows quicker adaptation for most wearers

### WEARERS PREFER CAMBER

Study shows more wearers preferred lenses made from Camber blanks to lenses made from single vision blanks

## OMNI Parameters

Pupil Distance	✓
Segment Height	✓
Vertex Distance	✗
Pantoscopic Angle	✗
Wrapping Angle	✗

## Camber Parameters

Pupil Distance	✓
Segment Height	✓
Vertex Distance	✓
Pantoscopic Angle	✓
Wrapping Angle	✓
Near Working Distance	✓

# Smart E 1.0 ADVANTAGES

- 1 Fully customization
- 2 Lifestyle customization
- 3 Large field of view
- 4 Optimum vision and wearing comfort
- 5 Guarantee quality satisfaction
- 6 Guarantee comfortable to wear

## Fitting Tips

- 1 Fitting height: 16 to 20mm
- 2 Fitting Cross above MRP 4mm
- 3 Near inset option: Available
- 4 Pantoscopic tilt: Required
- 5 Wrapping angle: Required
- 6 Back vertex distance: Required
- 7 Pupil distance: Required
- 8 Power compensation: Optional

## SWISSCOAT Technical Specification Plastic

Smart E 1.0						
Index	1.5	1.53	1.59	1.61	1.67	1.74
<b>Material</b>	Clear Camber SunAdapt XTRActive Transitions Gen8 Nupolar Drivewear	Clear NXT XTRActive Transitions Gen8	Clear Transitions Gen8 Drivewear	Clear Camber Armour UV++ Armour Sun UV++ SunAdapt XTRActive Transitions Gen8 Nupolar	Clear Camber Armour UV++ Armour Sun UV++ SunAdapt XTRActive Transitions Gen8 Nupolar	Clear Armour UV++ *Armour Sun UV++ Transitions Gen8
<b>Max Diameter</b>	75+5	75+5	75+5	75+5	75+5	75+5
<b>Fitting Height</b>	16mm to 20mm	16mm to 20mm	16mm to 20mm	16mm to 20mm	16mm to 20mm	16mm to 20mm
<b>Rx Power Range</b>	+6.00 ~ -8.00	+6.00 ~ -8.00	+6.00 ~ -9.00	+8.00 ~ -10.00	+8.00 ~ -11.00	+7.00~ -12.00
<b>Addition Power</b>	A+0.75 ~ A+3.50	A+0.75 ~ A+3.50	A+0.75 ~ A+3.50	A+0.75 ~ A+3.50	A+0.75 ~ A+3.50	A+0.75 ~ A+3.50
<b>Power Compensation</b>	YES	YES	YES	YES	YES	YES

Any power exceeds the power range, contact SWISSCOAT customer service officer.

\* 1.74 Armour Sun UV++ Coming Soon



**The technology behind MaxiWide lenses**

Developed with design optimization technology, MaxiWide is a progressive lens that provides superior optical and aesthetic qualities. MaxiWide design provides optimum binocular vision at all distance.

MaxiWide is designed for anyone looking for the best progressive lens that offers the highest quality of vision and maximum comfort.



Enhanced peripheral vision



Clearer vision while reading



Greater visual comfort when using computers



Fast adaption

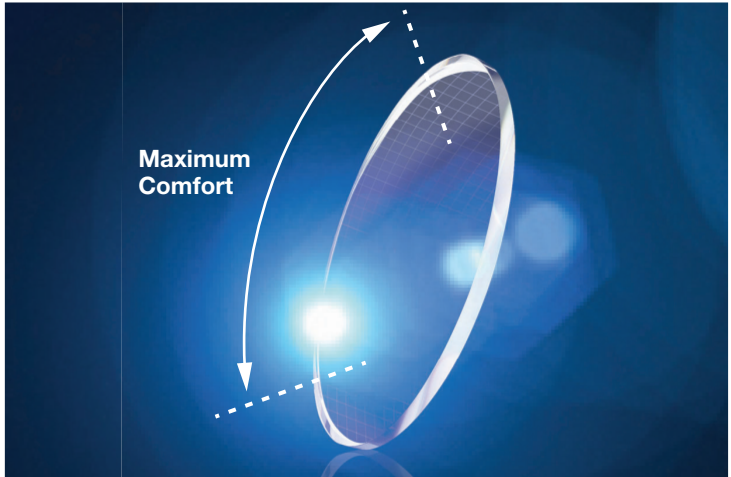

## DIGITAL DUAL BALANCE

Digital Dual Balance Technology means MaxiWide lenses ensure clear and wide vision when reading on smartphones and tablets, perfect for reading, both near and medium distances.



Blurry and narrow vision when reading on your smartphone



Clearer and wider vision when reading on your smartphone

## SHARPVIEW

SharpView Technology means MaxiWide lenses ensure sharp and wide vision at all distance.



Image of astigmatism of normal progressive lenses



Image of astigmatism of MaxiWide lenses

**OPTIMIZED**

MaxiWide adapts to each individual's way of looking as the lens is self-adjusting when it is being worn on the selected frame (optimized).

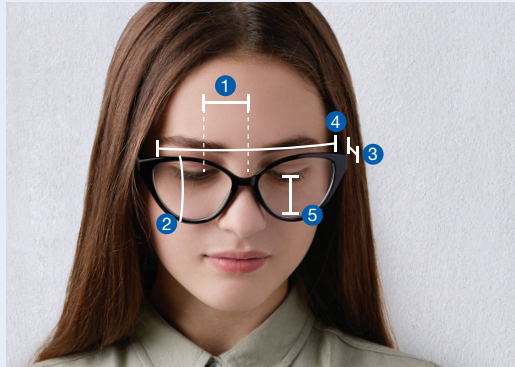

**MAXITHIN**

Maximum aesthetics and lightness: MAXIthin technology makes MaxiWide the thinnest lens in its category. Being lighter also provides greater comfort.

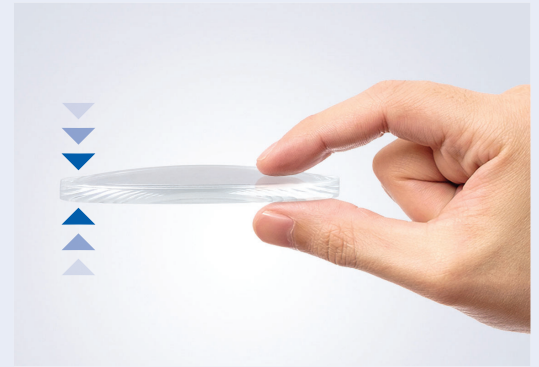

**Binocular BALANCE**

**Binocular Balance technology minimizes lateral blurriness**

A diverse level of astigmatism is measured between the nasal and temporal areas of the lens with much higher maximum levels in the nasal zone. It's challenging for the eye to be able to merge the image coming from each eye and form a single image. This imbalance causes diverse levels of lateral blurriness in both eyes, which implies that the optimal binocular vision is reduced.

The Binocular Balance technology allows us to balance the level of astigmatism on both sides of the pathway, minimizing the blurriness perceived by each eye. It improves binocular vision and provides the user with greater visual fields especially for intermediate and near vision.

Without Binocular Balance

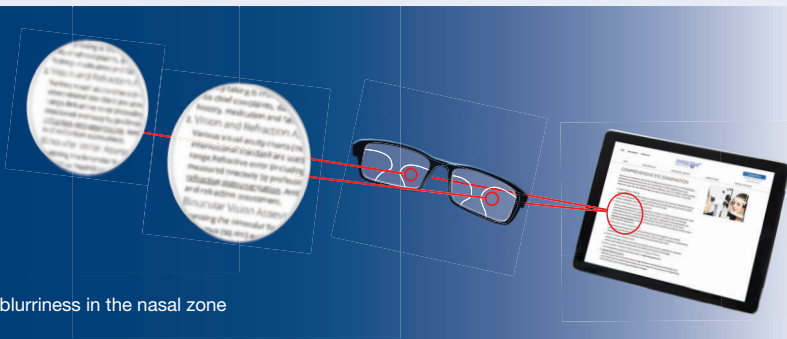

With Binocular Balance

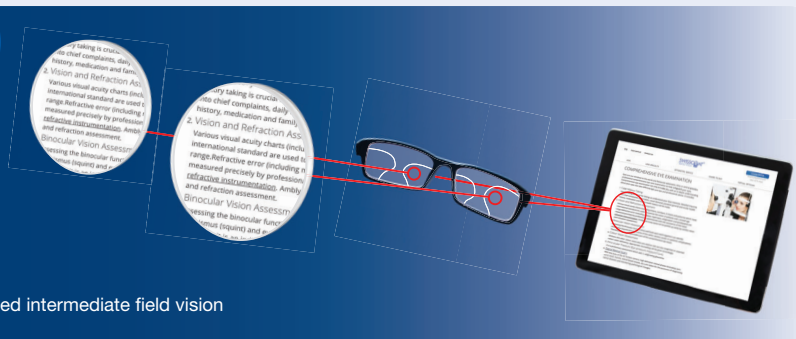

# Smart E 2.0 ADVANTAGES

- 1 Progressive lens with instant adaption
- 2 Excellent visual quality
- 3 Sharp stable vision at every distance
- 4 Advance technologies provide a highly added value position
- 5 Innovative design fits modern needs

## Fitting Tips

- 1 Fitting height: 16 to 20mm
- 2 Fitting Cross above MRP 4mm
- 3 Near inset option: Available
- 4 Pantoscopic tilt: Required
- 5 Wrapping angle: Required
- 6 Back vertex distance: Required
- 7 Pupil distance: Required
- 8 Power compensation: YES

## SWISSCOAT Technical Specification Plastic

Smart E 2.0						
Index	1.5	1.53	1.59	1.61	1.67	1.74
<b>Material</b>	Clear SunAdapt XTRActive Transitions Gen8 Nupolar Drivewear	Clear NXT XTRActive Transitions Gen8	Clear Transitions Gen8 Drivewear	Clear Armour UV++ Armour Sun UV++ SunAdapt XTRActive Transitions Gen8 Nupolar	Clear Armour UV++ Armour Sun UV++ SunAdapt XTRActive Transitions Gen8 Nupolar	Clear Armour UV++ *Armour Sun UV++ Transitions Gen8
<b>Max Diameter</b>	75+5	75+5	75+5	75+5	75+5	75+5
<b>Fitting Height</b>	16mm to 20mm	16mm to 20mm	16mm to 20mm	16mm to 20mm	16mm to 20mm	16mm to 20mm
<b>Rx Power Range</b>	+6.00 ~ -8.00	+6.00 ~ -8.00	+6.00 ~ -9.00	+8.00 ~ -10.00	+8.00 ~ -11.00	+7.00~ -12.00
<b>Addition Power</b>	A+0.75 ~ A+3.50	A+0.75 ~ A+3.50	A+0.75 ~ A+3.50	A+0.75 ~ A+3.50	A+0.75 ~ A+3.50	A+0.75 ~ A+3.50
<b>Power Compensation</b>	YES	YES	YES	YES	YES	YES

Any power exceeds the power range, contact SWISSCOAT customer service officer.

\* 1.74 Armour Sun UV++ **Coming Soon**



**Smart E 3.0**  
**A Revolutionary Progression Philosophy**



# Smart E 3.0

When using modern progressive, presbyopes often notice the swim effect. This occurs when the patient is looking at objects placed at different distances and is moving from the principal gaze position to the sides. With Smart E 3.0 and its revolutionary progression philosophy this effect can be eliminated and the gradient of astigmatism is involved in the solution.

## Improving visual perception

Smart E 3.0 is the first progressive design that considers the gradient of astigmatism to improve visual perception and to provide maximum comfort to the user. The human brain's perception is based on changes in the world around us. Through our senses it receives lots of information. Our brain is capable of focusing relevant issues and cancelling the non-relevant ones.

Smart E 3.0 is the safest option. It addressed to those consumers who enjoy confidence and comfort. Those demanding visual fields with very soft transition and ergonomic areas for their active lifestyle. Ideal for users sensitive to swim effect and demanders of optimum dynamic vision.



**Limitless Perception**  
Distance, intermediate and near feels wider and smoother



**Accelerated Adaptation**  
The easiest progressive lens to wear. Proven and tested



**Excellence in Visual Comfort**  
Comfortable transition when moving between areas in all over the lens surface on swim effect



**Sharp Vision at All Distance**  
Up to 20% unwanted astigmatism reduction



**Balanced Lens**  
Balanced and minimized amount of blurriness at both sides of the corridor



**Personalized Lens**  
Superb sharpness and precision in all gaze directions



**Adapted to the Digital World**  
Comfortable position when using hand held devices



**Ergonomic Design**  
Ensures a comfortable position of the near zone for natural reading

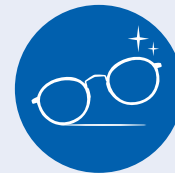

**Aesthetics and Lightness to the Maximum**  
Maximum reduction of thickness of positive lenses



**Optimized Near Vision**  
Reading zone correctly aligned

# Smart E 3.0 ADVANTAGES

- 1 Distance, intermediate and near feels wider and smooth
- 2 Accelerated adaptation
- 3 Excellence in visual comfort
- 4 Sharp vision at all distance
- 5 Balanced and minimized amount of blurriness at both sides of the corridor
- 6 Full personalized
- 7 Adapted to the digital world
- 8 Ergonomic design to ensure a comfortable position of the near zone for natural reading
- 9 Aesthetics and lightness to the max

## Fitting Tips

- 1 Fitting height: 16 to 20mm
- 2 Fitting cross above MRP 4mm
- 3 Near inset option: Available
- 4 Pantoscopic tilt: Required
- 5 Wrapping angle: Required
- 6 Back vertex distance: Required
- 7 Pupil distance: Required
- 8 Power compensation: Optional

## SWISSCOAT Technical Specification Plastic

Smart E 3.0						
Index	1.5	1.53	1.59	1.61	1.67	1.74
<b>Material</b>	Clear SunAdapt XTRActive Transitions Gen8 Nupolar Drivewear	Clear NXT XTRActive Transitions Gen8	Clear Transitions Gen8 Drivewear	Clear Armour UV++ Armour Sun UV++ SunAdapt XTRActive Transitions Gen8 Nupolar	Clear Armour UV++ Armour Sun UV++ SunAdapt XTRActive Transitions Gen8 Nupolar	Clear Armour UV++ *Armour Sun UV++ Transitions Gen8
<b>Max Diameter</b>	75+5	75+5	75+5	75+5	75+5	75+5
<b>Fitting Height</b>	16mm to 20mm	16mm to 20mm	16mm to 20mm	16mm to 20mm	16mm to 20mm	16mm to 20mm
<b>Rx Power Range</b>	+6.00 ~ -8.00	+6.00 ~ -8.00	+6.00 ~ -9.00	+8.00 ~ -10.00	+8.00 ~ -11.00	+7.00~ -12.00
<b>Addition Power</b>	A+0.75 ~ A+3.50	A+0.75 ~ A+3.50	A+0.75 ~ A+3.50	A+0.75 ~ A+3.50	A+0.75 ~ A+3.50	A+0.75 ~ A+3.50
<b>Power Compensation</b>	YES	YES	YES	YES	YES	YES

Any power exceeds the power range, contact SWISSCOAT customer service officer.

\* 1.74 Armour Sun UV++ **Coming Soon**

# Smart E Drive A Revolutionary Progression Philosophy



**Versatile Solution for Drivers**

## A solution for daily use that provides visual comfort for drivers



Although the vast majority of the time driving is used for distance vision, it is also necessary to perform tasks inside the car that require good vision at intermediate distances. Smart E Drive is the solution for daily use that ensures visual comfort of drivers.

During driving it is important not only how wide the field of vision is but also how clear and stable is in order to make quick gazes to look at the dashboard. Smart E Drive considers as-worn position parameters to provide extensive lateral vision for a better view of the exterior mirrors, other cars, road signs or pedestrian.

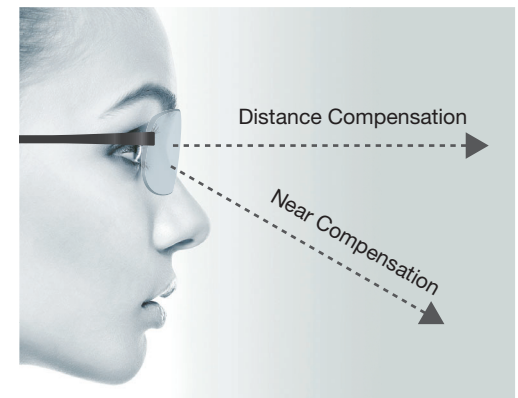

# Smart E Drive ADVANTAGES

- 1 Comfort and Safety
- 2 Ergonomic position while driving
- 3 Full personalized
- 4 Improved contrast in low light condition avoiding ghost images

## Fitting Tips

- 1 Fitting height: 17mm
- 2 Fitting cross above MRP 4mm
- 3 Near inset option: Available
- 4 Pantoscopic tilt: Required
- 5 Wrapping angle: Required
- 6 Back vertex distance: Required
- 7 Pupil distance: Required
- 8 Power compensation: Optional

## SWISSCOAT Technical Specification Plastic

Smart E Drive						
Index	1.5	1.53	1.59	1.61	1.67	1.74
<b>Material</b>	Clear SunAdapt XTRActive Transitions Gen8 Nupolar Drivewear	Clear NXT XTRActive Transitions Gen8	Clear Transitions Gen8 Drivewear	Clear Armour UV++ Armour Sun UV++ SunAdapt XTRActive Transitions Gen8 Nupolar	Clear Armour UV++ Armour Sun UV++ SunAdapt XTRActive Transitions Gen8 Nupolar	Clear Armour UV++ *Armour Sun UV++ Transitions Gen8
<b>Max Diameter</b>	75+5	75+5	75+5	75+5	75+5	75+5
<b>Fitting Height</b>	17mm	17mm	17mm	17mm	17mm	17mm
<b>Rx Power Range</b>	+6.00 ~ -8.00	+6.00 ~ -8.00	+6.00 ~ -9.00	+8.00 ~ -10.00	+8.00 ~ -11.00	+7.00~ -12.00
<b>Addition Power</b>	A+0.75 ~ A+3.50	A+0.75 ~ A+3.50	A+0.75 ~ A+3.50	A+0.75 ~ A+3.50	A+0.75 ~ A+3.50	A+0.75 ~ A+3.50
<b>Power Compensation</b>	YES	YES	YES	YES	YES	YES

Any power exceeds the power range, contact SWISSCOAT customer service officer.

\* 1.74 Armour Sun UV++ Coming Soon

STRESS FREE  
STANDARD  
ANTI-REFLECTIVE

**PREMIUM COATING**

IMPACT FREE  
SPC ADVANCED  
MAXIMUM

# Standard Anti-reflective Coating

## ADVANTAGES

1. Defuse light reflections on the front and back surface of the lens.
2. Allowing more light to pass through and improving visual acuity.
3. Improves the sharpness and clarity of your vision by diffusing light reflections on your lenses.
4. The dual surface anti-reflective coating provides crisp, clear vision in all light conditions.



## COATING THAT COME WITH SWISSCOAT LENSES

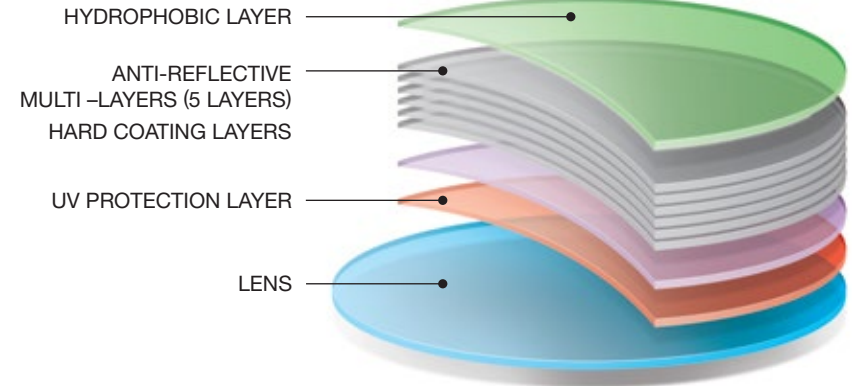

# SPC 2.0 New Advanced Coating

## ADVANTAGES

1. 5 times impact resistant\*
2. Stronger scratch resistant
3. Reduce smudges
4. Help prevent scratches
5. Significantly easier to clean

**SPC 2.0 advanced anti-reflective coating go above and beyond simply reducing reflections, it is our most durable anti-reflective coating, a long-life and durable anti-reflective comprised of unique formulars which having advantages of**

- 5 times impact resistant\*
- Improved scratch resistance
- Improved hydrophobic (water repellent)
- Oleophobic (reduces finger prints)
- Anti-Static (repels dust)
- Durability (longer lifespan)

\* High Index Material

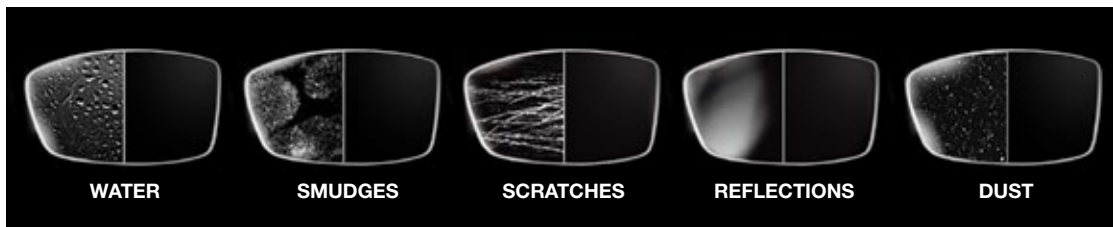

# Maxiivue (MV3.0)

## A New Level for Vision Performance and Protection

So Clear, So Safe ..... An exclusive anti-reflecting coating technology from SWISSCOAT. The new MV3.0 takes anti-reflective coating to a new level for vision performance and protection. The new MV3.0 endure daily wear and tear.

Standard anti-reflective AR coating cannot do a good job of reducing reflection, the coating still have a noticeable greenish hue. SWISSCOAT MV3.0, the premium anti-reflective coating diminishes reflections on your lens to the minimum. The MV3.0 eliminates those greenish light flares that can be present on standard anti-reflective coatings.

The MV3.0 anti-reflective coating achieves up to 99.7% visible light transmission rate, it is SWISSCOAT top premium coating.

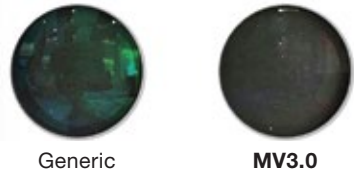

### ADVANTAGES

1. Extreme low reflection
2. 5 times stronger impact resistant \*
3. Maximum durability
4. 100% UV protection
5. Scratch resistant
6. Water, dirt, and dust repellent

\*High Index Material

# StressFree

Blue light protection – overexposure to short wavelength blue light has been clinically linked to sleep disorders, and with the average adult spending over 10 hours a day on digital devices, StressFree blue light blocking coating limit the amount of harmful blue light reaching the eye by 15%.

StressFree coating designed to block blue light have a noticeable blue hue, it is suggested to only use this coating for computer glasses and not for glasses that you will be wearing full time indoors and out.

### ADVANTAGES

1. Blue light protection.
2. Reduce the amount of high energy blue light reaching the eyes.
3. Tremendously prevent light behind you from bouncing off the back of the lens and back into your eyes.
4. Reduce eye fatigue.
5. Enhance better vision.
6. Increase visual contrast.

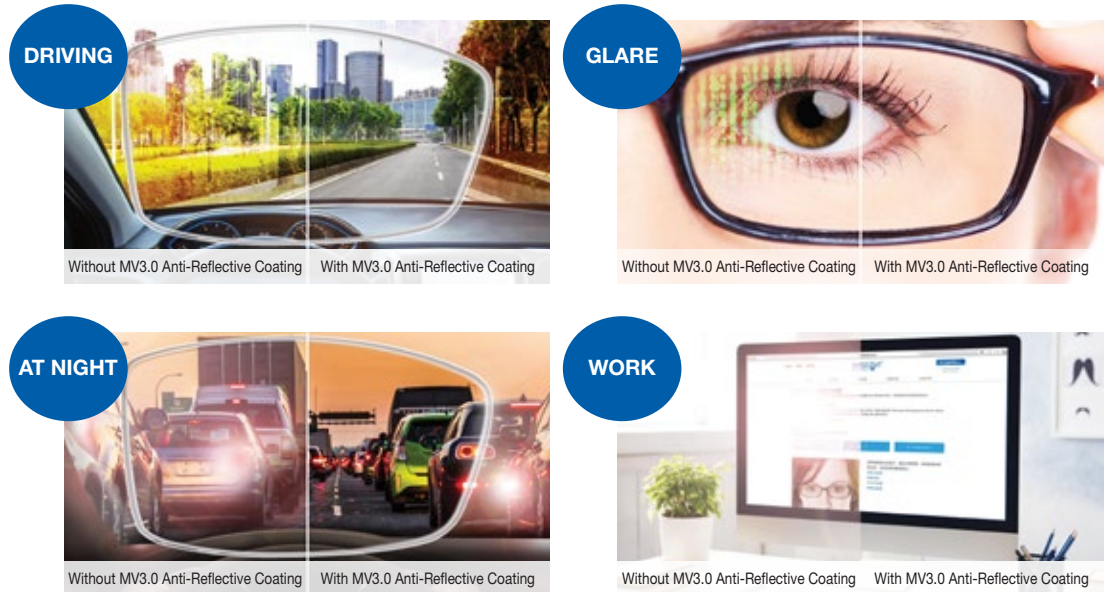

Clear multifunctional lenses with very low reflection for everyday wear. Increases colour contrast as well as filtering out excess blue.

**Blue light filtering**  
★★★★★  
**Low reflection**  
★★★★★



Moderate blue filtering for light/intermediate screen users. Blue Reflection Coating (non-tinted clear lens).

**Blue light filtering**  
★★★★★  
**Low reflection**  
★★★

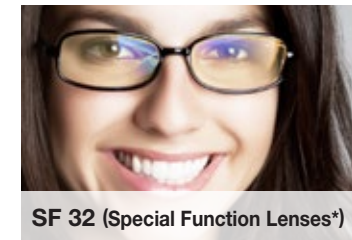

Extra strong blue blocker. Ideal for heavy screen users, such as those who work at computers for long hours, particularly at night\*.  
\*Not recommended for general everyday use because of its strong yellow tint.  
\*Excessive blue light will affect the balance of Melatonin.

**Blue light filtering**  
★★★★★  
**Low reflection**  
★★★

\*SF32/SF noflex only applicable to 1.5, 1.6, 1.67 clear lens



# ImpactFREE

SWISSCOAT ImpactFREE Nano-Thin Anti-Impact coating provides excellent protection against shock and sudden impact. With just 520nm of ImpactFREE coating, lenses can withstand tough conditions, avoid damage and are also light and comfortable to wear. By applying ImpactFREE coating, the perfect balance of performance and comfort of high index lenses.

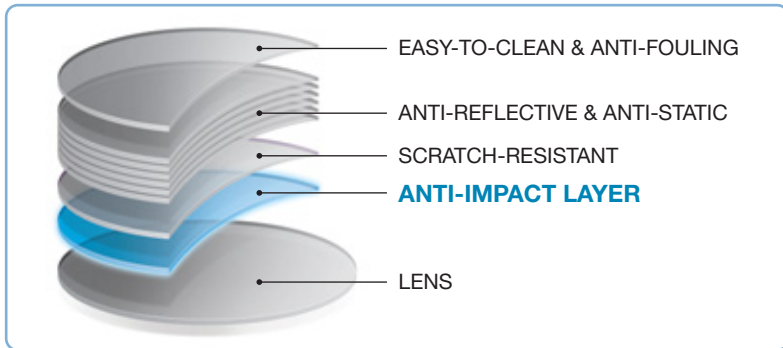

## ImpactFREE the Impact resistant lens



**SAFER AND MORE SECURE**

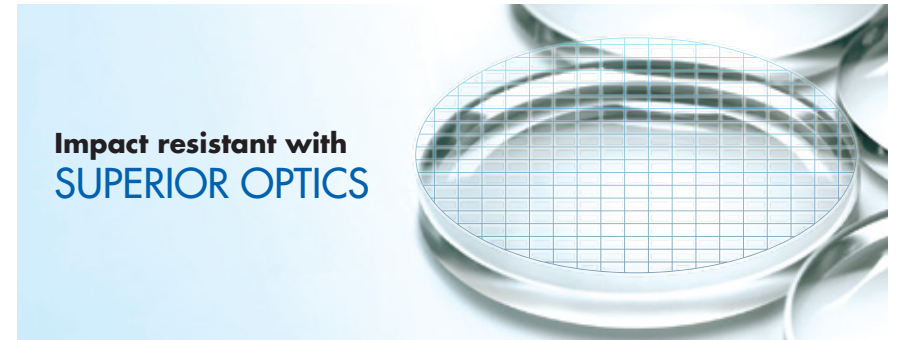

### ADVANTAGES

1. Ideal for all activities, ImpactFREE coating effectively protects your eyes.
2. Exceptional protection and ensures excellent clarity.
3. Provides maximum durability and shatterproof performance.
4. Safer and more secure, the perfect balance of performance to all hi-index lenses.

SUNGLASS ADAPT  
MULTI-POOR  
ACTIVE WEAR

**LENS MATERIAL**

SAFETY WEAR  
ARMOUR SUN 420  
DRIVER WEAR

SWISSCOAT Lens Material/Lens Type Table

Index	Single Vision			Myopia Monitoring		Sport	Bifocal		The Indoor			Progressive		
Lens Material/ Lens Type	Single Vision	SoloTECH	SoloTECH Individual TM	KidsPRO	Kids ProTECH MYO ProTECH	iAction iAction TM	Conventional	Digital Seamless	Conventional Office	Precision Office iRoom 4m iOffice 2m iReader 1.3m	Conventional	High Definition	Precision My World Smart Evolution	
Mineral Glass	✓	N/A	N/A	N/A	N/A	N/A	✓	N/A	✓	N/A	✓	N/A	N/A	
Plastic	✓	✓	✓	✓	N/A	✓	✓	✓	✓	✓	✓	✓	✓	
Trivex	✓	✓	✓	N/A	N/A	✓	N/A	✓	N/A	✓	N/A	✓	✓	
Nxt	✓	✓	✓	N/A	N/A	✓	N/A	N/A	N/A	N/A	N/A	✓	✓	
Polycarbonate	✓	✓	✓	N/A	N/A	✓	N/A	N/A	N/A	✓	N/A	✓	✓	
Armour UV++	✓	✓	✓	N/A	✓	✓	N/A	✓	N/A	✓	N/A	✓	✓	
Armour Sun UV++	✓	✓	✓	N/A	✓	✓	N/A	✓	N/A	✓	N/A	✓	✓	
SunAdapt	✓	✓	✓	N/A	N/A	✓	N/A	✓	N/A	✓	N/A	✓	✓	
Transitions Gen8	✓	✓	✓	N/A	N/A	✓	✓	✓	N/A	✓	N/A	✓	✓	
Nupolar	✓	✓	✓	N/A	N/A	✓	N/A	N/A	N/A	N/A	N/A	✓	✓	
Drivewear	✓	✓	✓	N/A	N/A	✓	N/A	N/A	N/A	N/A	N/A	✓	✓	

# Plastic



Plastic Single Vision lens from SWISSCOAT is the best quality and always manufactured using the best premium material, with wide selection of choice in index from 1.5 to 1.74 depending on your individual requirement. We guarantee you the greatest possible visual comfort.

Plastic Technical Specification

Index	1.5	1.56	1.61	1.67	1.74
Material	Clear SunAdapt Transitions Gen8 XTRActive Nupolar Drivewear	Clear Sunsensor Sundance	Clear Armour UV++ Amour Sun UV++ SunAdapt Transitions Gen8 XTRActive Nupolar	Clear Armour UV++ Amour Sun UV++ SunAdapt Transitions Gen8 XTRActive Nupolar	Clear Armour UV++ *Amour Sun UV++ Transitions Gen8
Density	1.31/g/cm <sup>3</sup>	1.28/g/cm <sup>3</sup>	1.48/g/cm <sup>3</sup>	1.35/g/cm <sup>3</sup>	1.47/g/cm <sup>3</sup>
Abbe Value	58	38	40	32	32
Stock Asp	✓	✓	✓	✓	✓
Spherical	✓	✓	✓	N/A	N/A
Rx-able	✓	✓	✓	✓	✓
Tintable	✓	✓	✓	✓	✓

\* 1.74 Armour Sun UV++ **Coming Soon**

# Mineral

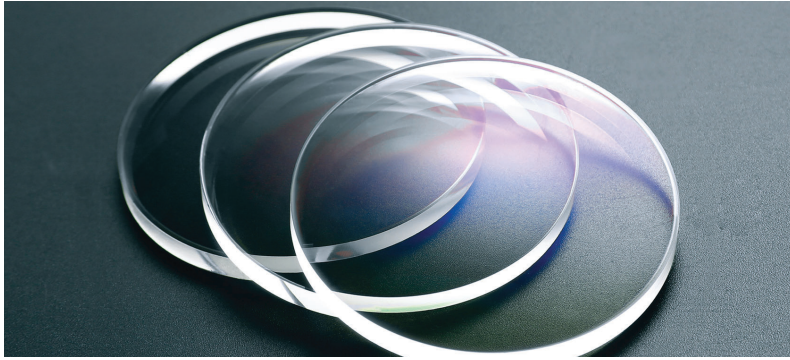

Mineral Glass Single vision lens from SWISSCOAT is the best quality and always manufactured using the premium mineral material in the market, with wide selection of choice in index from 1.523 to 1.90.

Mineral Technical Specification

Index	1.523	1.604	1.71	1.802	1.9
Lens Design	Spherical	Spherical	Spherical	Spherical	Spherical
Lens Base	Clear, PBX, PGX	Clear, PBX, PGX	Clear	Clear	Clear
Density	2.55/g/cm <sup>3</sup>	2.65/g/cm <sup>3</sup>	2.99/g/cm <sup>3</sup>	3.65/g/cm <sup>3</sup>	3.99/g/cm <sup>3</sup>
Abbe Value	58	56	38	35	31
Stock lens power range Sph	PL ~ -4.00	N/A	-3.00 ~ -10.00	N/A	N/A
Stock lens power range cyl	Cyl -2.00	N/A	Cyl -2.00	N/A	N/A
Rx Lens power range	+6.00 ~ -8.50	+7.50 ~ -15.00	+9.00 ~ -17.50	-4.00 ~ -20.00	-6.00 ~ -24.00
AR coating	Green	Green	Green	Green	Green
Tinting	No	No	No	No	No

Any order exceed the above Rx production power, customer can contact our customer service officer for confirmation.

# SAFEwear

Single vision lens by SWISSCOAT SAFEwear in Trilogy material guarantee you clear vision, Safety and Lightweight. SWISSCOAT SAFEwear also blocks out 100% of harmful UV rays that provide full protection to your eyes. No matter what your vision needs are, whether work or play, sport or hobby, SAFEwear is your right choice.

Today's consumer has more choices than ever, SAFEwear lenses deliver superior optics, superior impact resistance when compared with other lens materials.

## ADVANTAGES

1. Superior optics and clear vision.
2. Safety - superior impact resistant.
3. Thin and Lightweight.
4. Block out 100% harmful UV rays.



SAFEwear Technical Specification	
Index	1.53
Density	1.11/g/cm <sup>3</sup>
Abbe Value	45
Lens Design	Spherical
Lens Base	Clear, Transitions Gen8, Nupolar, XTRActive
UV Protection	100%
Tinting	No

# ACTIVEwear

Single vision by SWISSCOAT ACTIVEwear lens in polycarbonate material, the lens is 10 times stronger, 30% lighter and up to 50% thinner than conventional plastic lenses. They absorb all harmful UV light and are virtually shatter proof.



ACTIVEwear Technical Specification	
Index	1.59
Density	1.47/g/cm <sup>3</sup>
Abbe Value	30
Lens Design	Spherical
Lens Base	Clear, Transitions Gen8, Nupolar, Drivewear
UV Protection	100%
Tinting	No

# NXT

Every NXT sport performance lens is designed to accomplish two goals. Deliver an unbelievably rich visual experience and stand up to the physical demands of your customer's high-performance lifestyles.



## ADVANTAGES

### Visual Experience

1. Optical clarity of NXT material provides an uninhibited view of the world.
2. Polarization blocks the blinding glare that is a major impediment to a pure visual experience.
3. NXT Varia™ photochromic technology dynamically responds to changing light conditions.
4. NXT Rx lenses offer the same optimal visual experience for prescription sports glasses.
5. NXT lenses are enhanced with advanced lens treatments such as anti-reflective, hydrophobic and mirror coatings to provide an unobstructed view of the world.

### Physical Experience

1. 100% UVA/UVB blockage is built into every NXT lens to protect eyes from harmful UV rays.
2. All-day comfort is made possible through the lightweight performance of NXT material.
3. Safety and protection are enabled by the extreme impact resistance of NXT material.
4. Unique lens geometries, shapes and frame types will stand the test of time thanks to the unmatched durability of NXT material.
5. NXT lenses are enhanced with advanced scratch-resistant coatings to put up with the wear and tear of every-day life.

The ball visually “pops”, and the contours of the green are revealed through the NXT MAX Golf Tint. Engineered for the unique visual challenges of the golf course.

OPTICAL SEPECTRUM 100% UVA/B-VLT 20% The NXT Golf enhances critical details of the fairway and green, suppressing visual information you don't need, and simplifying the white of the ball to help you track your shot. Specially tuned to the game of golf, this tint is ideal for and course, in the sun or under the clouds.



Golf

Dim the sun, brighten the shadow, and keep your eyes on every detail with the NXT Outdoor.

## OPTICAL SEPECTRUM 100% UVA/B-VLT 17%

The NXT Outdoor is designed to enhance the visual spectrum available in natural environments, By cutting down the harsh direct sunlight and brightening the details in shadow, this tint enhances your view of everything around you, relaxing your eyes at the same time.



Outdoor

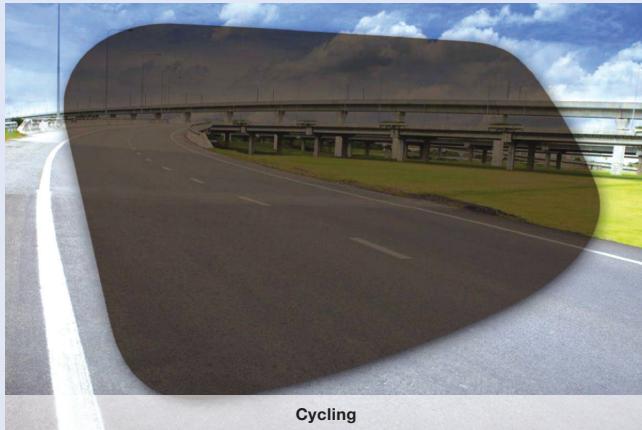

Cycling

## GLARE Control

Blinding glare is created when light is reflected off smooth, shiny surfaces such as roads, water and snow. NXT polarized lenses control glare by allowing the wearer to cut through visual noise and hear what light is truly saying.

## Dynamic Brightness Control

NXT Photochromic lenses respond to changing light conditions by adjusting the level of tint from lighter to darker, allowing you to translate light in any condition for maximum performance and comfort.

Orange comes in somewhere between red, brown, and yellow lenses, and as such, works well in darker, cloudy weather.

OPTICAL SEPECTRUM 100% UVA/B-VLT 20%

**BEST FOR:** mountain biking on hazy, cloudy days.

**NOT FOR:** bright, sunny days.



Shooting



With NXT Contrast and Dynamic Brightness Control, it filters light at different wavelengths to enhance your visual experience by controlling contrast, color and definition, and responds to changing light conditions by adjusting the level of tint from lighter to darker, allowing you to translate light in any condition for maximum performance and comfort.

**ACTION B** is best for cycling, running and every road activities.



Sunny Day



Cloudy Day

## With NXT Contrast & Dynamic Brightness Control

### Contrast Control

Far more than a cosmetic characteristic, the color of and NXT Photochromic lens is a critical component that filters light at different wavelengths to enhance your visual experience by controlling contrast, color and definition. So you get lenses that look great. And perform even better.

### Dynamic Brightness Control

Photochromic lenses respond to changing light conditions by adjusting the level of tint from lighter to darker, allowing you to translate light in any condition for maximum performance and comfort.



Sunny Day



Cloudy Day

## NXT Technical Specification

Index	1.53	Lens Base	Color filter, Photochromic
Density	1.11/g/cm <sup>3</sup>	UV Protection	100%
Abbe Value	45	Tinting	No
Lens Design	Spherical		



# Armour UV++

## Armour Leading Towards a New Protective Standard

- Double-sided UV light absorption through the material (UVA, UVB)
- Not only can it block UVA and UVB, it can also block the majority of blue-violet light (400nm~420nm) over 90%.
- The material filters high energy visible light (420nm~450nm)

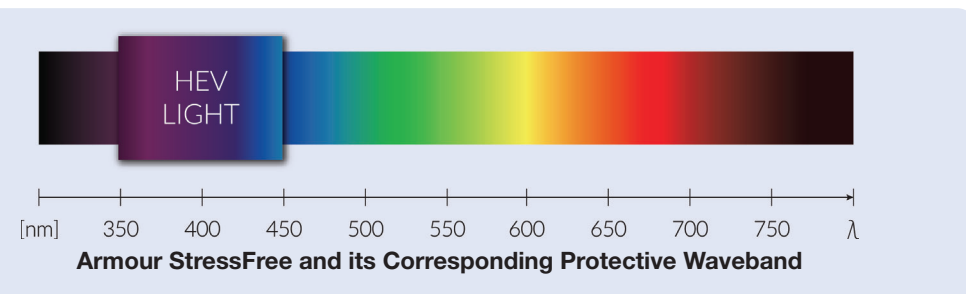
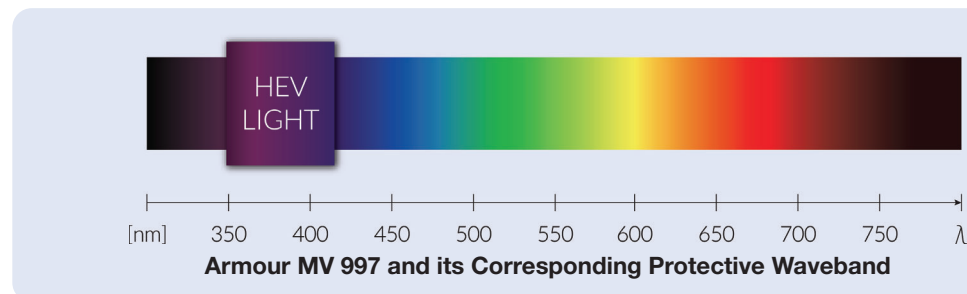
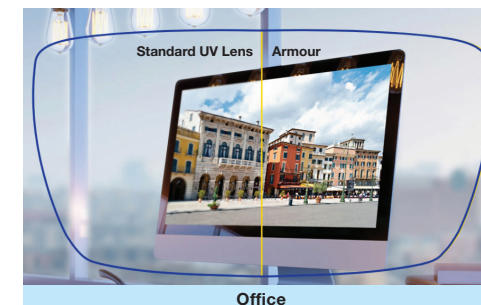
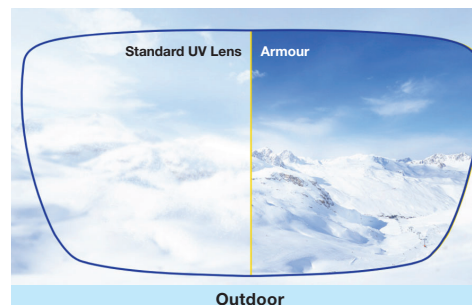

\*Data for reference only. Blocking rate may vary with lens thickness and materials.

## Benefits of Equipping Armour (Health and Visual Effects)

- Health Aspects:
  - Reduce the risk of cataracts caused by UV light
  - Prevention of accelerated aging eye skin to avoid the occurrences of dull skin, laxity, wrinkles, pigmentation, etc.

## Armour Lens Material

- Suitable for:
  - People who concern about healthy eyes
  - Women or professional women who concern about eye skin care
  - People who suffered eye disorders or have just undergone eye surgery
  - People who often outgoing/exposed to strong light at work but unsuitable to wear light-filtering lenses
  - People who are long-term sitting in front of the computer/smart phone and other electronic screens

Armour UV++ Technical Specification			
Index	1.61	1.67	1.74
Density	1.48/g/cm <sup>3</sup>	1.35/g/cm <sup>3</sup>	1.47/g/cm <sup>3</sup>
Abbe Value	40	32	32
Lens Design	Spherical, Aspherical		
Lens Base	Clear		
UV Protection	100%		
Tinting	No		

# Armour Sun UV++

- Unique coating Photochromic
- Fast Coating Photochromic technology
- Great uniform Colors
- 100% protection against UVA and UVB
- Reduces HEV Blue Light
- Multiple refractive Index

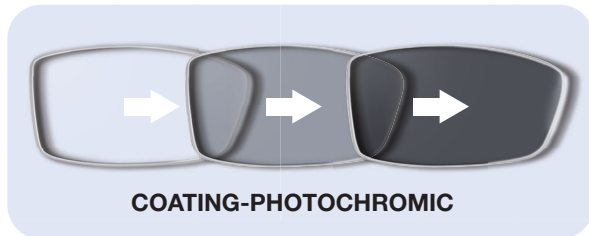

## Extra UV protection against blue light

Armour Sun effectively absorbs high-energy blue light generated from digital electronic devices. Armour Sun lens is highly sensitive. It is colorless transparent indoor and changes according to UV strength outdoor. The stronger UV color, the darker lens color is. Light transmittance will increase quickly when coming back indoor from outdoor.

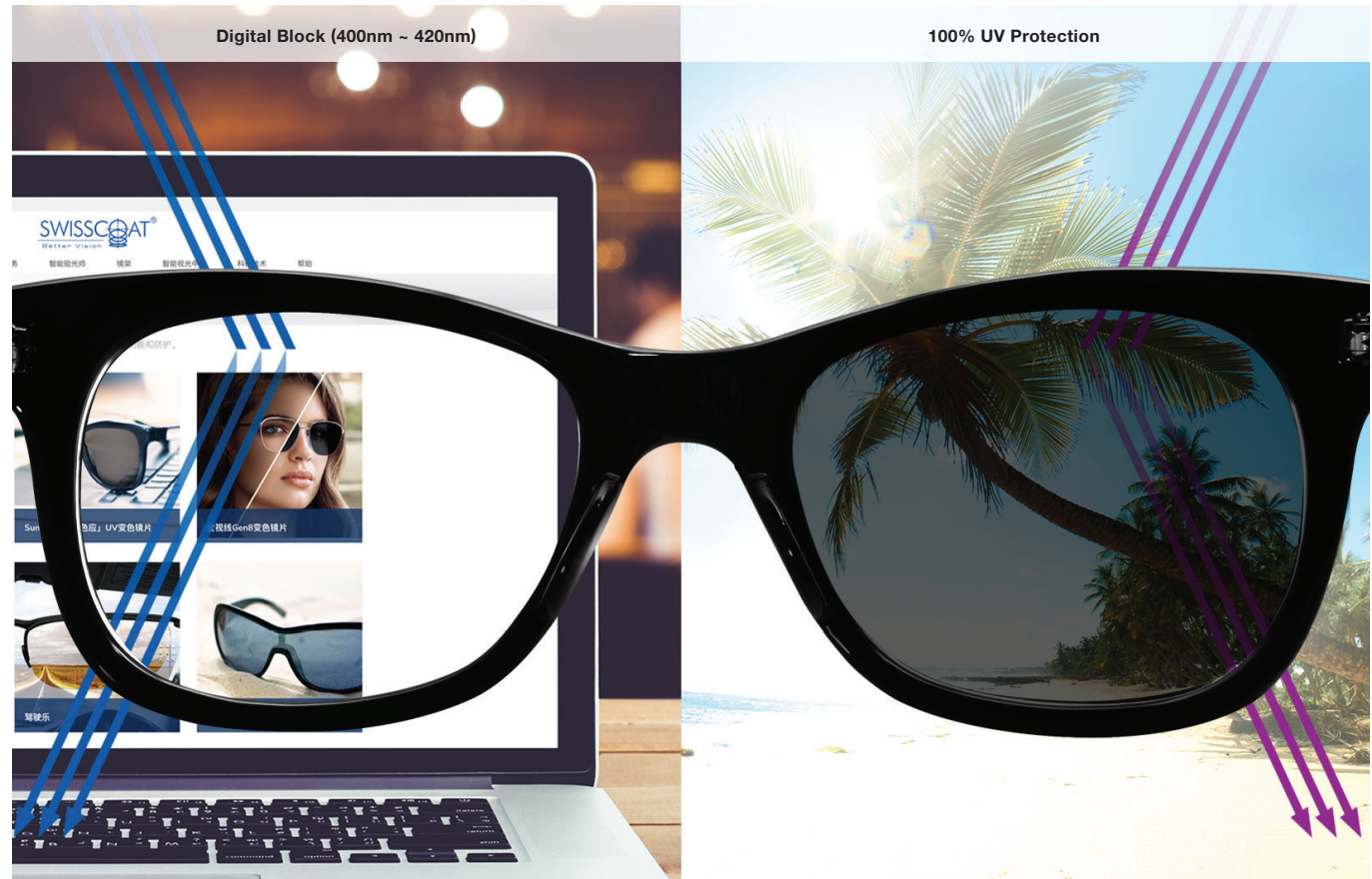

### Armour Sun UV++ Technical Specification

Index	1.61	1.67	*1.74	Lens Base	Photochromic: Brown, Grey
Density	1.48/g/cm <sup>3</sup>	1.35/g/cm <sup>3</sup>	1.47/g/cm <sup>3</sup>	UV Protection	100%
Abbe Value	40	32	32	Tinting	No
Lens Design	Spherical, Aspherical			Availability	Single Vision, Bifocal, Progressive

\* 1.74 Armour Sun UV++ **Coming Soon**

# SunAdapt

Swisscoat SunAdapt lenses provide convenient protection from several types of glare. Including the kind that can seriously diminish vision.

In sunlight, mid-light or indoors, SunAdapt lenses are the optimal choice for your everyday lenses.



**SunAdapt lenses are clear indoors and at night and darken outdoors to adapt to changing light conditions. SunAdapt lenses may be right for you...**

- A all-in-one lens with Power correction, Sun block and HEV filtration function.
- Available in multifocals, and FSV with anti-reflective treatment or blue light filtering coating, effectively reduce the amount high energy blue light entering the eyes.

**SunAdapt Lenses:**

- Quickly darken outdoors and quickly fade back to clear indoors.
- Allow the right amount of light to reach your eyes in most lighting conditions.
- Adapt automatically to lessen eye fatigue.
- Protect your eyes outdoors from most kinds of glare and block 100% UVA and UVB.
- Provide comfort, convenience and protection indoors and out.

SunAdapt Technical Specification			
Index	1.5	1.61	1.67
Density	1.31/g/cm <sup>3</sup>	1.48/g/cm <sup>3</sup>	1.35/g/cm <sup>3</sup>
Abbe Value	58	40	32
Lens Design	Spherical, Aspherical		
Lens Base	Photochromic: Brown, Grey		
UV Protection	100%		
Tinting	No		

# Transitions Signature Gen8

Transitions Signature Gen 8 lenses automatically adapt to changing light conditions for comfortable vision and hassle free protection both indoors and outdoors all day long. Responding to the light around you, they intelligently change from clear to dark when you go outdoors and back to clear when you return inside.

By optimizing the amount of light your eyes receive, Transitions lenses also help reduce glare, eye fatigue and strain, for more effortless sight.

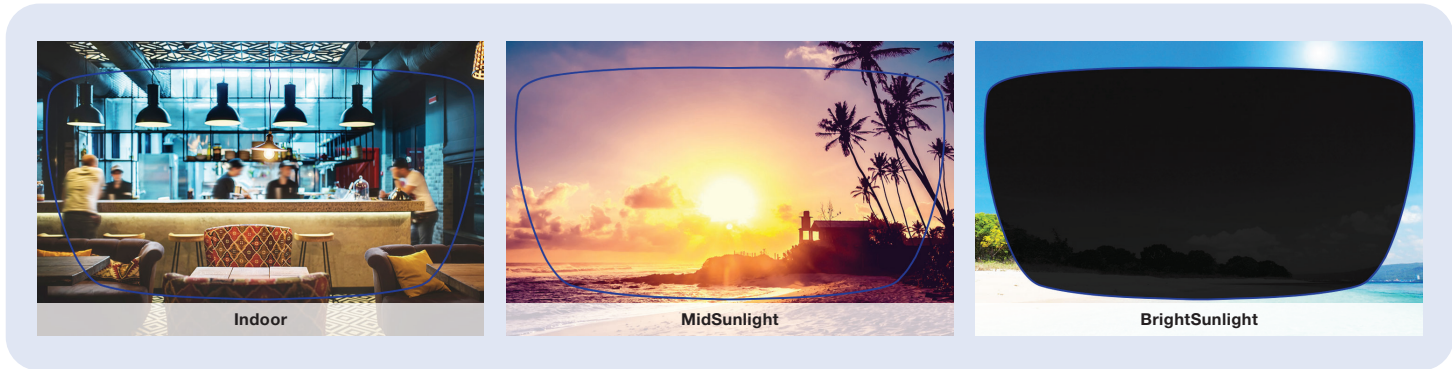

**Transitions Signature Gen 8 Lenses are the result of over 5-years of research and development by Transitions Optical, all Transitions Lenses undergo Life360 testing that encompasses:**

- **Laboratory Measurements** - as a baseline for standard temperature variation testing
- **Real World Measurements** - with >200 real life conditions, representing more than a thousand scenarios
- **Live Wearer Testing** - with real wearers to provide insights into wearer experience
- **Real World Modeling** - mimics the behavior of lenses in real world conditions

**Breakthrough Technology delivers a new frontier of performance**

Disruptive nano-composite matrix creates zones where the dyes can move freely, activate and fadeback faster, without sacrificing darkness or durability.

New generation of ultra-agile dyes faster, without sacrificing darkness or durability, improves the responsiveness, darkness, longevity of the performance and consistency across colors.

- Good for everyday life
- Activation speed up to 30%\* faster
- Returns to clear 3 minutes faster than last generation
- Darkness even darker
- Fully clear indoors
- Long lasting performance
- Block 100% of UV rays
- Help protect against harmful blue light

\*Compare with Transitions Signature VII

Transitions Gen8 Technical Specification								
Index	1.5	1.53	1.59	1.61	1.67	1.74	Lens Base	Transitions Gen8: Brown, Grey
Density	1.31/g/cm <sup>3</sup>	1.11/g/cm <sup>3</sup>	1.47/g/cm <sup>3</sup>	1.48/g/cm <sup>3</sup>	1.35/g/cm <sup>3</sup>	1.47/g/cm <sup>3</sup>	UV Protection	100%
Abbe Value	58	45	30	40	32	32	Tinting	No
Lens Design	Spherical, Aspherical							

# Transitions XTRActive

Transitions lenses provide convenient protection from several types of glare. Including the kind that can seriously diminish vision. In sunlight, mid-light or indoors,

Transitions lenses are the optimal choice for your everyday lenses.

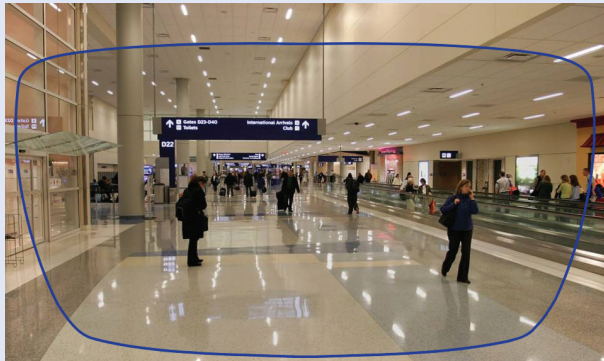

Indoor



Outdoor



Driving

## WHO

Transitions XTRActive lenses provide superior darkness outdoors, in all temperatures; will darken modestly behind a windshield; and have an attractive tint indoors.

Transitions XTRActive lenses may be right for you...

- If you spend a lot of time outdoors
- If you prefer a very dark lens outdoors
- If you like an attractive tint indoors
- If you want the convenience of one pair of eyeglasses
- If you want some darkening behind the windshield

Available in gray, single vision multifocals.

## WHY

### Transitions XTRActive lenses:

- Are the darkest everyday lens available even in hot temperatures
- Are your best option if you want a slight tint indoors
- Automatically adjust to changing light conditions outdoors
- Provide moderate activation behind the windshield
- Protect your eyes outdoors from most kinds of glare and block 100% UVA and UVB

### Transitions XTRActive Technical Specification

Index	1.5	1.53	1.61	1.67
Density	1.31/g/cm <sup>3</sup>	1.11/g/cm <sup>3</sup>	1.48/g/cm <sup>3</sup>	1.35/g/cm <sup>3</sup>
Abbe Value	58	45	40	32
Lens Design	Spherical, Aspherical			
Lens Base	Transitions XTRActive: Grey			
UV Protection	100%			
Tinting	No			

# Sundance Color Photochromic

**Lenses You Can Count On  
In All Situations**



Swisscoat SunDance is high quality middle index plastic photochromic lens in 5 different colour to choose (Purple, Blue, Brown, Pink and Grey). It is light in weight, efficient in darkening and lightening capabilities, performing whatever the weather, whatever the activity. This responsive high performance lens adapts to your lifestyle.



Purple

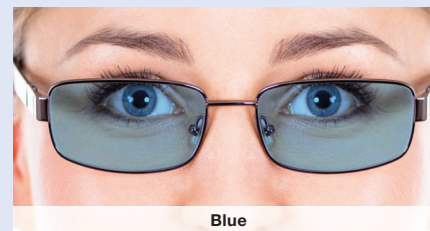

Blue

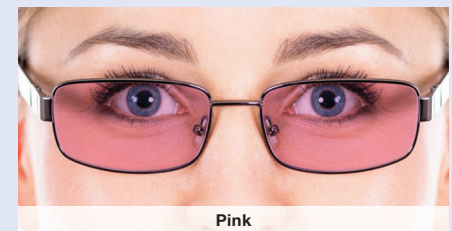

Pink



Brown

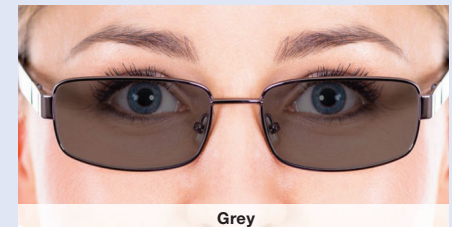

Grey

# NuPolar Color Lens Simulation

The worldwide leader in polarized lenses. NuPolar is the best all around sun lens with proven quality and the glare and UV blocking you need.

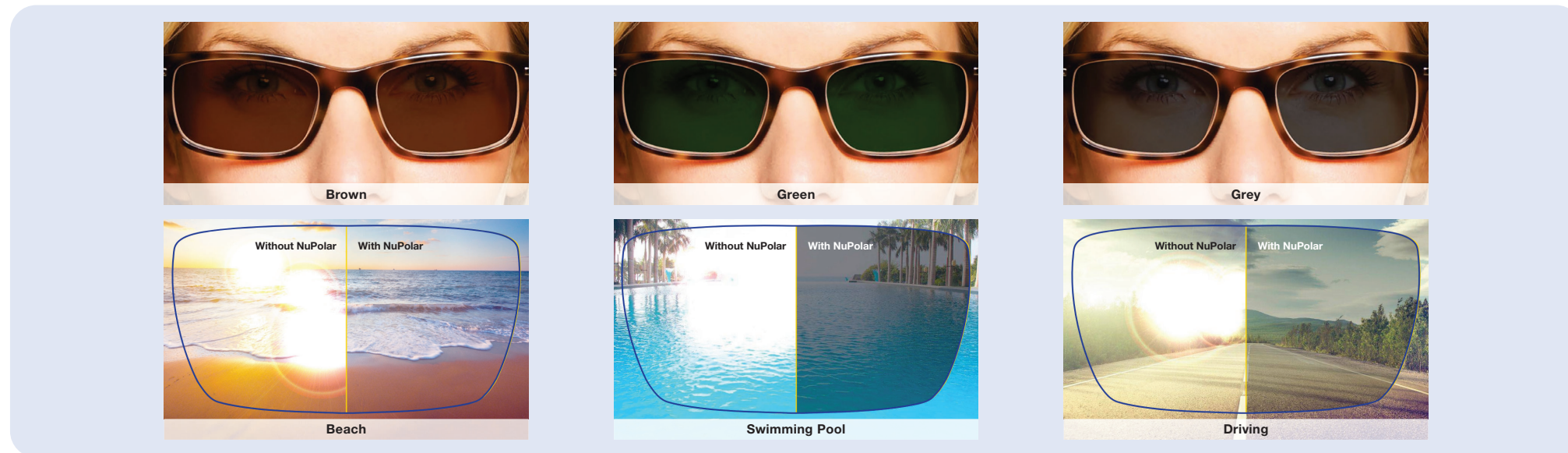

**WHO**

NuPolar lenses may be right for you...

- If you want the total glare protection only polarized lenses offer
- If you want a really dark sun lens outdoors in all conditions
- If you enjoy the outdoors, especially activities on or around water and snow
- If you want a selection of tints
- If you want the only polarized lens that meets all accepted performance standards

Available in gray, brown, green and copper; single vision and multifocals.

Also available in non-prescription.

**WHY**

NuPolar lenses:

- Provide the best vision in bright sunlight
- Make your outdoor activities more enjoyable
- Lessen squinting and crows' feet
- Make driving safer by cutting glare
- Let you see true color

**Nupolar Technical Specification**

Index	1.5	1.53	1.59	1.61	1.67
Density	1.31/g/cm <sup>3</sup>	1.11/g/cm <sup>3</sup>	1.47/g/cm <sup>3</sup>	1.48/g/cm <sup>3</sup>	1.35/g/cm <sup>3</sup>
Abbe Value	58	45	30	40	32
Lens Design	Spherical, Aspherical				
Lens Base	Brown, Grey, (Green only 1.5, 1.59)				
UV Protection	100%				
Tinting	No				



# Drivewear

Drivewear Transitions lenses are the only lenses designed specifically for the driving task. They will automatically adjust to the best color and appropriate darkness behind the windshield - all to optimize your driving performance.



**WHO** Drivewear Transitions lenses are the only lenses designed specifically for the driving task. They will automatically adjust to the best color and appropriate darkness behind the windshield - all to optimize your driving performance.

Drivewear Transitions lenses may be right for you...

- If you want the best visual acuity for daytime driving
- If you are concerned with UV damage and blinding glare
- If you want a great lens for driving and for outdoors
- If you want the benefits of polarization and photochromics combined
- If you want the right darkness and the right color for changing daylight driving conditions

Available in single vision bifocals and no-line bifocals. Also available in non-prescription.

**WHY** Drivewear Transitions lenses:

- Adapt to changing light conditions to enhance visual performance while driving
- Polarized to make driving safer by cutting glare
- Make driving more enjoyable by improving contrast
- Lessen eye fatigue
- Protect your eyes outdoors from glare and block 100% UVA and UVB rays

Drivewear Technical Specification				
Index	1.5	1.59	Lens Base	Transitions Polarized
Density	1.31/g/cm <sup>3</sup>	1.47/g/cm <sup>3</sup>	UV Protection	100%
Abbe Value	58	30	Tinting	No
Lens Design	Spherical			

# Armour Sun UV++

GO TO ARMOUR SUN VIDEO



OR  
SCAN QR CODE



LENS DESIGN  
SPHERICAL  
ANTI-REFLECTION COLOR

## **MINERAL GLASSES**

ABBE VALUE  
GREEN



# Visual Comfort

Mineral Glass Single vision lens from SWISSCOAT is the best quality and always manufactured using the premium mineral material in the market, with wide selection of choice in index from 1.523 to 1.90 depending on your individual requirement. We guarantee you the greatest possible visual comfort.

## Deluxe Progressive

SWISSCOAT Deluxe mineral progressive, a progressive solution to budget mineral progressive wearer, Deluxe provide comfort vision in your daily life.

SWISSCOAT mineral progressive also in Minipro and Genius design.

## Office

SWISSCOAT conventional office is supplied with CR39 and mineral glass material. SWISSCOAT conventional office is created to the wearers who works long time in an office and in front of a computer, it is an ideal lens for alleviating computer vision syndrome and the alternative for reading glasses.

### Technical information

Index	1.523	1.604	1.71	1.802	1.9
Lens Design	Spherical	Spherical	Spherical	Spherical	Spherical
Lens	Clear, PBX, PGX	Clear, PBX, PGX	Clear	Clear	Clear
Density	2.55/g/cm <sup>3</sup>	2.65/g/cm <sup>3</sup>	2.99/g/cm <sup>3</sup>	3.65/g/cm <sup>3</sup>	3.99/g/cm <sup>3</sup>
Abbe Value	58	42	38	35	31
Anti-reflection color	Green	Green	Green	Green	Green

BICYCLING  
SURFING

**SUNRANGE**

SKINNING

## UV Protected Sunglasses for SWISSCOAT'S Customers



Special sun filtered lenses newly developed to protect your eyes.

At SWISSCOAT, we offer high quality sun filtered lenses to customers looking for high-quality sun protection for their sunglasses. These newly developed designs are made with innovation in mind, and aim to protect your eyes from the harsh UV rays that commonly damage our eyes.

### Why is sun protection so important for your sunglasses ?

Most people know how important it is to protect your skin from UV rays, but we still see many people unaware and apathetic towards protecting their eyes. What many people don't realize is, these rays can lead to conditions such as cataracts, macular degeneration and eye strain. UVA and UVB rays can cause damage to the whites of our eyes, the retina, the lens, the iris, the cornea and the eyelids, meaning nearly your entire eye is exposed to damage. What's more, the sun's bright light can lead to tired and overworked eyes, causing eye strain and dryness. This is why most professionals will advise you wear sunglasses on all sunny days, particularly when the sun's rays are at their strongest.

At SWISSCOAT, you can find a range of sun lenses that will protect you from long and short-term damage, while not compromising on style and fashion when choosing sunglasses.



# SunSport Mirror

The SunSports Mirror is available in 10 colour to choose. With SWISSCOAT sunsports colour, opticians can now offer more choice of fashion lenses to their customer that can at the same time protect your eyes from ultra-bright light as well.



Tank

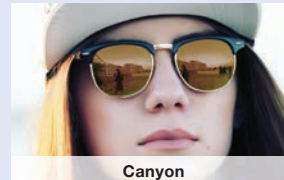

Canyon

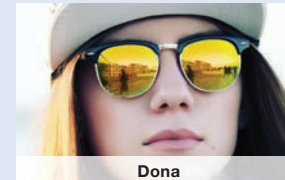

Dona

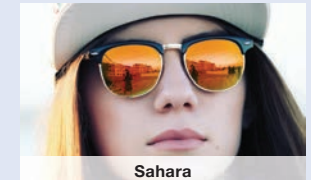

Sahara



Pink Panther



Pine Green

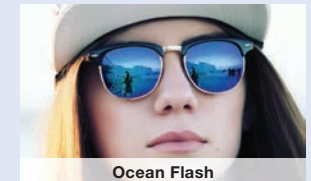

Ocean Flash

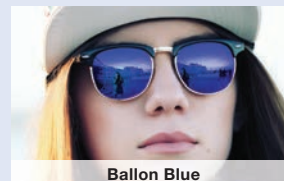

Ballon Blue

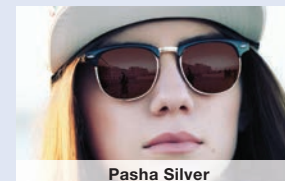

Pasha Silver

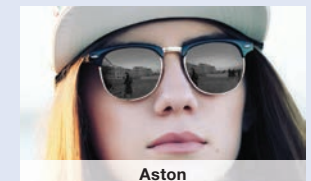

Aston

## Range of application

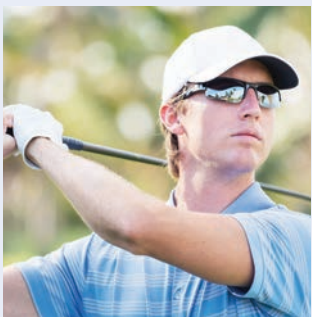

Golf



Skimg



Driving



Fishing

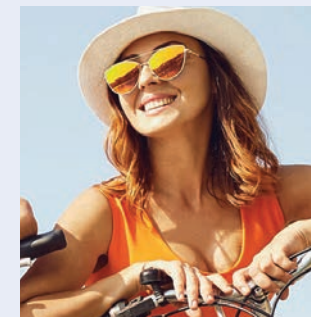

Bicycling



Beach Volleyball

# Color Tint Function by SWISSCOAT

**Yellow Color Filter Lens** Hardly absorb visibly light, it can improve the contrast and provide more accurate images in foggy environment of dusk.

**Gradient Color Filter Lenses**, Outdoor can block strong sunlight. Indoor or weak light can be used, and it is beautiful and generous.

**Other Color Filter Lenses** are both practical and decorative, full of fashion elements.

**Blue Color Filter Lens** can absorb light of color equally and reduce the light intensity. Its is darker color, it gives better vision.

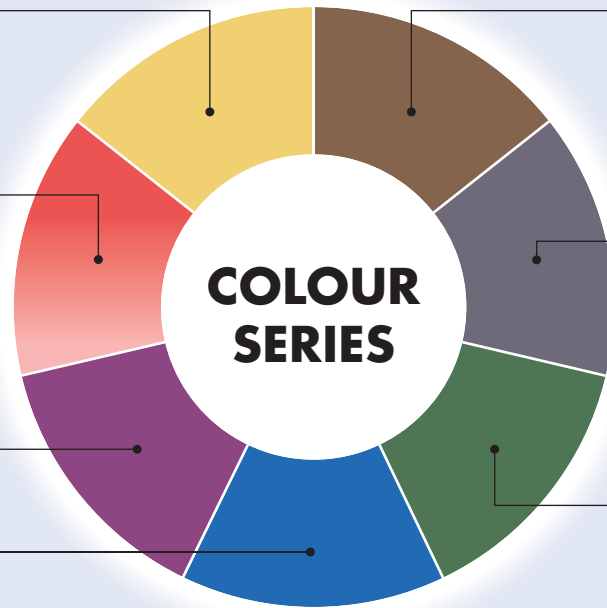

**Brown Filter Color Lens** can filter out a lot of blue light, it can improve the contrast and clarity of vision, better vision in foggy weather.

**Grey Filter Color Lens** can absorb light of color equally and reduce the intensity of light. Wearing grey color lenses to watch the scenery will not cause chromatic aberration, giving a more realistic and natural view.

**Green Filter Color lens**, it maximizes the amount of green light reaching the eyes, make people have a comfortable vision, reduce eye fatigue.

## SWISSCOAT Color Stabilizing Technology

All The color filter lenses apply SWISSCOAT latest Color Stabilizing Technology to avoid color fading out after some time lenses expose under the Sun.

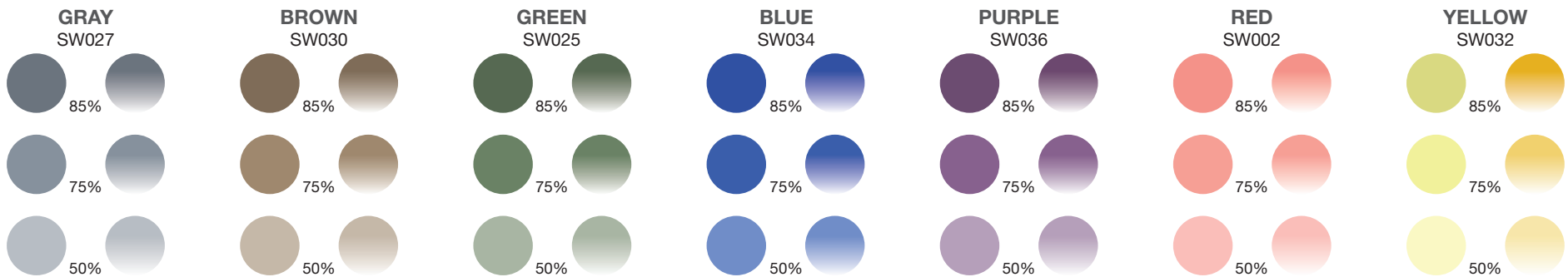



# SUN Filter Lens



A range of Color Sun filtered lenses that absorb harmful UVA / B and offer the ideal eye protection for any active lifestyle in the sun. The cool colourful shades of life under the sun. SWISSCOAT offers you a complete range of colour for prescription lenses. Talk to our customer service officer if there is any unique color you want us to produce for any of your Rx prescription lenses.



TRANSITIONS  
MULTIPOIAR  
YOUNG BIFOCAL

## **LENS** RANGE AVAILABILITIES

SPC ADVANCED  
IMPACT FREE  
DRIVEWEAR



SWISSCOAT Single Vision Stock Power Range (Spheric)

Index	Clear	ImpactFree
1.5	60mm Sph +0.25 ~ +6.00 Cyl -3.00 65mm Sph +6.00 ~ -6.00 Cyl -2.00 65mm Sph +1.00 ~ +4.00 Cyl -2.25 ~ -3.00 65mm Sph 0.00 ~ -4.00 Cyl -2.25 ~ -3.00 70mm Sph +6.00 ~ -6.00 Cyl -2.00 75mm Sph 0.00 ~ -4.00 Cyl -2.00	N/A
1.53 Trivex	65mm Sph +0.25 ~ +4.00 Cyl -2.00 70mm Sph 0.00 ~ -4.00 Cyl -2.00	N/A
1.56	65mm Sph +0.25 ~ +6.00 Cyl -2.00 70mm Sph 0.00 ~ -6.00 Cyl -2.25 ~ -4.00 73mm Sph 0.00 ~ -6.00 Cyl -2.00	N/A
1.59 PC	65mm Sph +1.00 ~ +3.00 Cyl -2.00 70mm Sph +0.25 ~ +0.75 Cyl -2.00 70mm Sph 0.00 ~ -3.00 Cyl -2.00	N/A
1.61	65mm Sph +0.25 ~ +4.00 Cyl -2.00 65mm Sph +0.25 ~ +6.00 Cyl -2.00 only for HCMC; SPC 70mm Sph -6.25 ~ -8.00 Cyl -3.00 75mm Sph 0.00 ~ -6.00 Cyl -3.00 75mm Sph 0.00 ~ -5.00 Cyl -3.25 ~ -4.00	65mm Sph +0.25 ~ +6.00 Cyl -2.00 70mm Sph -6.25 ~ -8.00 Cyl -3.00 75mm Sph 0.00 ~ -6.00 Cyl -3.00



SWISSCOAT Single Vision Stock Power Range (Aspheric)

Index	Clear	ImpactFree
1.5	65mm Sph +0.25 ~ +4.00 Cyl -2.00	N/A
1.56	65mm Sph +1.75 ~ +6.00 Cyl -2.00	N/A
1.61	65mm Sph +0.25 ~ +6.00 Cyl -2.00 70mm Sph -6.25 ~ -8.00 Cyl -3.00 75mm Sph 0.00 ~ -6.00 Cyl -3.00	65mm Sph +0.25 ~ +4.00 Cyl -2.00 70mm Sph -6.25 ~ -8.00 Cyl -3.00 only for SPC 75mm Sph 0.00 ~ -6.00 Cyl -3.00
1.61	65mm Sph +4.25 ~ +6.00 Cyl -2.00 70mm Sph +2.25 ~ +4.00 Cyl -2.00 75mm Sph +0.25 ~ +2.00 Cyl -2.00 70mm Sph -8.25 ~ -10.00 Cyl -2.00 75mm Sph -6.25 ~ -8.00 Cyl -2.00 75mm Sph 0.00 ~ -8.00 Cyl -2.25 ~ 4.00 80mm Sph 0.00 ~ -6.00 Cyl -2.00	65mm Sph +0.25 ~ +4.00 Cyl -2.00 70mm Sph -6.25 ~ -8.00 Cyl -4.00 70mm Sph -6.25 ~ -10.00 Cyl -2.00 only for SPC 75mm Sph 0.00 ~ -6.00 Cyl -3.00
1.67 SoloTECH	75mm Sph -4.25 ~ -9.00 Cyl -2.00 70mm Sph -9.25 ~ -13.00 Cyl -2.00	N/A
1.74	65mm Sph -10.50 ~ -12.00 Cyl -2.00 (0.50 per step) 65mm Sph -12.50 ~ -15.00 (0.50 per step) only for SPC 70mm Sph -6.25 ~ -10.00 Cyl -2.00 70mm Sph -6.25 ~ -10.00 Cyl -3.00 only for SPC 75mm Sph -5.00 ~ -6.00 Cyl -2.00 75mm Sph -3.00 ~ -6.00 Cyl -3.00 only for SPC	N/A



**SWISSCOAT Single Vision Stock Power Range**

Index	SWISSCOAT Transitions	Transitions Gen8/XTRActive (1.5 Only)
1.5 Spheric ●	65mm Sph +0.25 ~ +2.00 Cyl - 1.75 70mm Sph +0.25 ~ +2.00 Cyl -0.25 ~ -2.00 70mm Sph 0.00 ~ -4.00 Cyl 0.00 ~ -2.00	65mm Sph +0.25 ~ +2.00 Cyl - 1.75 70mm Sph +0.25 ~ +2.00 Cyl -0.25 ~ -2.00 70mm Sph 0.00 ~ -4.00 Cyl -2.00
1.61 Spheric ●	65mm Sph +0.25 ~ +4.00 Cyl -2.00 70mm Sph -6.25 ~ -8.00 Cyl -1.75 75mm Sph 0.00 ~ -6.00 Cyl -2.00	65mm Sph +0.25 ~ +6.00 Cyl -2.00 70mm Sph -6.25 ~ -8.00 Cyl -1.75 75mm Sph 0.00 ~ -6.00 Cyl -2.00
167 Aspheric ●	N/A	70mm Sph -7.25 ~ -8.00 Cyl -1.25 ~ -2.00 75mm Sph -6.25 ~ -8.00 Cyl -2.00 80mm Sph -4.00 ~ -6.00 Cyl -2.00
1.74 Aspheric	N/A	N/A



Index	Drivewear/Nupolar
1.5 Spheric ●●	Plano

SWISSCOAT Rx Power Range (Plastic)

Index	Single Vision / Solotech / Solotech TM						
	1.5	1.53	1.56	1.59	1.61	1.67	1.74
Clear	+9.75 ~ -11.75	+8.00 ~ -9.50	+14.50 ~ -12.50	+9.00 ~ - 10.00	+9.00 ~ -13.50	+10.25 ~ -15.25	+10.00 ~ -17.50
Armour UV++	N/A	N/A	N/A	N/A	+10.25 ~ -12.50	+10.25 ~ -15.25	+10.00 ~ -17.00
*Armour Sun UV++	N/A	N/A	N/A	N/A	+10.25 ~ -12.50	+10.25 ~ -15.25	N/A
SunAdapt	+7.50 ~ -10.50	N/A	N/A	N/A	+11.50 ~ -12.50	+11.50 ~ -13.50	N/A
Transitions Gen8	+7.50 ~ -10.50	+8.00 ~ -8.00	N/A	+9.00 ~ -9.00	+11.50 ~ -12.50	+11.50 ~ -13.50	+10.00 ~ -13.00
Transitions XTRActive	+7.50 ~ -10.50	+8.00 ~ -9.50	N/A	N/A	+8.75 ~ -11.00	+9.25 ~ -13.00	N/A
Drivewear	+7.50 ~ -9.00	N/A	N/A	+8.00 ~ -9.50	N/A	N/A	N/A
Nupolar	+7.50 ~ -9.00	N/A	N/A	+9.00 ~ -10.00	+9.00 ~ -11.00	+9.00 ~ -11.00	N/A

Any power exceeds the power range, contact SWISSCOAT customer service officer.

\* 1.74 Armour Sun UV++ **Coming Soon**

**SWISSCOAT Rx Power Range (Bifocal)**

	Flat-Top		Kry-Top	Young Bifocal
Index	Clear	Transitions	70/28 Clear	Clear
1.5	+8.25 ~ -9.50	+6.50 ~ -9.00	+7.50 ~ -6.50	+7.50 ~ -11.50
1.53	N/A	N/A	N/A	N/A
1.56	N/A	N/A	N/A	N/A
1.59	N/A	N/A	N/A	N/A
1.61	+8.50 ~ -12.00	N/A	N/A	N/A
1.67	+9.00 ~ -16.00	N/A	N/A	N/A
1.74	N/A	N/A	N/A	N/A
	Add +1.00 ~ +3.50	Add +1.00 ~ +3.00	Add +1.00 ~ +3.00	Add +1.00 ~ +3.00

	Digital Seamless						
Index	1.5	1.53	1.56	1.59	1.61	1.67	1.74
Clear	+6.00 ~ -5.00	+4.50 ~ -5.00	N/A	N/A	+5.50 ~ -6.00	+8.00 ~ -7.50	+5.50 ~ -8.00
Armour UV++	N/A	N/A	N/A	N/A	+5.50 ~ -6.00	+8.00 ~ -7.50	+5.50 ~ -8.00
*Armour Sun UV++	N/A	N/A	N/A	N/A	+5.50 ~ -6.00	+8.00 ~ -7.50	N/A
SunAdapt	+6.00 ~ -5.00	N/A	N/A	N/A	+7.00 ~ -7.50	+7.50 ~ -8.00	N/A
Transitions Gen8	+6.00 ~ -5.00	+4.50 ~ -5.00	N/A	N/A	+7.00 ~ -6.50	+6.00 ~ -7.00	+4.00 ~ -8.00
Transitions XTRActive	+6.00 ~ -5.00	+4.50 ~ -5.00	N/A	N/A	+7.00 ~ -6.50	+5.00 ~ -7.00	N/A
Drivewear	N/A	N/A	N/A	N/A	N/A	N/A	N/A
Nupolar	N/A	N/A	N/A	N/A	N/A	N/A	N/A
	Add +0.75 ~ +3.50						

Any power exceeds the power range, contact SWISSCOAT customer service officer.

\* 1.74 Armour Sun UV++ **Coming Soon**

**SWISSCOAT Rx Power Range (Myopia Control)**

	Kidspro						
Index	1.5	1.53	1.56	1.59	1.61	1.67	1.74
Clear	+8.50 ~ -8.00	N/A	N/A	N/A	+7.50 ~ -11.00	N/A	N/A
	Add +0.75 ~ +2.00						

	Kids ProTECH / MYO ProTECH						
Index	1.5	1.53	1.56	1.59	1.61	1.67	1.74
Armour UV++	N/A	N/A	N/A	N/A	0.00 ~ -10.00	+7.00 ~ -8.00	N/A
*Armour Sun UV++	N/A	N/A	N/A	N/A	0.00 ~ -10.00	+7.00 ~ -8.00	0.00 ~ -12.00
	Add +1.50, +2.00						

Any power exceeds the power range, contact SWISSCOAT customer service officer.

\* 1.74 Armour Sun UV++ **Coming Soon**



SWISSCOAT Rx Power Range (Sport)

	iAction - Single Vision						
Index	1.5	1.53	1.56	1.59	1.61	1.67	1.74
Clear	+6.00 ~ -4.00	+6.00 ~ -4.00	N/A	+6.00 ~ -4.00	+6.00 ~ -4.00	+6.00 ~ -4.00	+6.00 ~ -4.00
NXT (Fixed Tint)	N/A	+6.00 ~ -4.00	N/A	N/A	N/A	N/A	N/A
NXT (Mirror Coated)	N/A	+6.00 ~ -4.00	N/A	N/A	N/A	N/A	N/A
NXT (Photochromic)	N/A	+6.00 ~ -4.00	N/A	N/A	N/A	N/A	N/A
SunAdapt	+6.00 ~ -4.00	N/A	N/A	N/A	+6.00 ~ -4.00	+6.00 ~ -4.00	N/A
*Armour Sun UV++	N/A	N/A	N/A	N/A	N/A	N/A	N/A
Transitions Gen8	+6.00 ~ -4.00	+6.00 ~ -4.00	N/A	+6.00 ~ -4.00	+6.00 ~ -4.00	+6.00 ~ -4.00	+6.00 ~ -4.00
Transitions XTRActive	+6.00 ~ -4.00	+6.00 ~ -4.00	N/A	N/A	+6.00 ~ -4.00	+6.00 ~ -4.00	N/A
Nupolar	+6.00 ~ -4.00	+6.00 ~ -4.00	N/A	+6.00 ~ -4.00	+6.00 ~ -4.00	+6.00 ~ -4.00	N/A
Drivewear	+6.00 ~ -4.00	N/A	N/A	+6.00 ~ -4.00	N/A	N/A	N/A

	iAction TM - Single Vision						
Index	1.5	1.53	1.56	1.59	1.61	1.67	1.74
Clear	+6.00 ~ -6.00	+6.00 ~ -6.00	N/A	+6.00 ~ -6.00	+6.00 ~ -6.00	+6.00 ~ -6.00	+6.00 ~ -6.00
NXT (Fixed Tint)	N/A	+6.00 ~ -6.00	N/A	N/A	N/A	N/A	N/A
NXT (Mirror Coated)	N/A	+6.00 ~ -6.00	N/A	N/A	N/A	N/A	N/A
NXT (Photochromic)	N/A	+6.00 ~ -6.00	N/A	N/A	N/A	N/A	N/A
SunAdapt	+6.00 ~ -6.00	N/A	N/A	N/A	+6.00 ~ -6.00	+6.00 ~ -6.00	N/A
*Armour Sun UV++	N/A	N/A	N/A	N/A	N/A	N/A	N/A
Transitions Gen8	+6.00 ~ -6.00	+6.00 ~ -6.00	N/A	+6.00 ~ -6.00	+6.00 ~ -6.00	+6.00 ~ -6.00	+6.00 ~ -6.00
Transitions XTRActive	+6.00 ~ -6.00	+6.00 ~ -6.00	N/A	N/A	+6.00 ~ -6.00	+6.00 ~ -6.00	N/A
Nupolar	+6.00 ~ -6.00	+6.00 ~ -6.00	N/A	+6.00 ~ -6.00	+6.00 ~ -6.00	+6.00 ~ -6.00	N/A
Drivewear	+6.00 ~ -6.00	N/A	N/A	+6.00 ~ -6.00	N/A	N/A	N/A

Any power exceeds the power range, contact SWISSCOAT customer service officer.

\* 1.74 Armour Sun UV++ **Coming Soon**

## SWISSCOAT Rx Power Range (The Indoor)

	Conventional Office						
Index	1.5	1.53	1.56	1.59	1.61	1.67	1.74
Clear	+6.00 ~ -5.50	N/A	N/A	N/A	N/A	N/A	N/A
	ADD +0.75; +1.25; +1.75; +2.25						

	Daily Office / iRoom 4m / iOffice 2m / iReader 1.3m						
Index	1.5	1.53	1.56	1.59	1.61	1.67	1.74
Clear	+6.00 ~ -8.00	+4.50 ~ -8.00	N/A	+6.50 ~ -9.00	+5.00 ~ -12.00	+10.00 ~ -11.00	+8.50 ~ -14.00
Armour UV++	N/A	N/A	N/A	N/A	+5.00 ~ -12.00	+10.00 ~ -11.00	+8.50 ~ -14.00
*Armour Sun UV++	N/A	N/A	N/A	N/A	+5.00 ~ -12.00	+10.00 ~ -11.00	N/A
SunAdapt	+4.50 ~ -8.00	N/A	N/A	N/A	+7.50 ~ -12.00	+7.50 ~ -13.00	N/A
Transitions Gen 8	+4.50 ~ -8.00	+4.50 ~ -8.00	N/A	+5.50 ~ -9.00	+7.50 ~ -12.00	+7.50 ~ -13.00	+8.00 ~ -14.00
Transitions XTRActive	N/A	N/A	N/A	N/A	N/A	N/A	N/A
Nupolar	N/A	N/A	N/A	N/A	N/A	N/A	N/A
	Add +0.75 ~ +3.50						

Any power exceeds the power range, contact SWISSCOAT customer service officer.

\* 1.74 Armour Sun UV++ **Coming Soon**

## SWISSCOAT Rx Power Range (Progressive)

	Conventional Progressive - MiniPro / Genius		
Index	1.5	1.61	1.67
Clear	+6.00 ~ -7.50	+7.50 ~ -11.00	+7.50 ~ -11.50
	Add +0.75 ~ +3.50		

	Digital Progressive - NECO / Precision / Myworld / Smart E						
Index	1.5	1.53	1.56	1.59	1.61	1.67	1.74
Clear	+6.50 ~ -8.00	+5.00 ~ -8.00	N/A	+4.00 ~ -8.50	+5.00 ~ -9.50	+8.00 ~ -9.50	+4.00 ~ -9.00
Armour UV++	N/A	N/A	N/A	N/A	+5.00 ~ -9.50	+8.00 ~ -9.50	+4.00 ~ -9.00
*Armour Sun UV++	N/A	N/A	N/A	N/A	+5.00 ~ -9.50	+8.00 ~ -9.50	+4.00 ~ -9.00
SunAdapt	+4.50 ~ -8.00	N/A	N/A	N/A	+7.50 ~ -10.00	+6.00 ~ -10.50	N/A
Transitions Gen 8	+4.50 ~ -8.00	+5.00 ~ -8.00	N/A	+4.00 ~ -9.00	+7.50 ~ -10.00	+6.00 ~ -10.50	+8.00 ~ -10.00
Transitions XTRActive	+4.50 ~ -8.00	+5.00 ~ -8.00	N/A	N/A	+7.50 ~ -10.00	+6.00 ~ -10.50	N/A
Drivewear	+5.00 ~ -7.00	N/A	N/A	+4.50 ~ -7.50	N/A	N/A	N/A
Nupolar	+4.50 ~ -7.00	+5.50 ~ -6.50	N/A	+5.00 ~ -9.00	+6.00 ~ -9.00	+6.00 ~ -11.00	N/A
	Add +0.75 ~ +3.50						

Any power exceeds the power range, contact SWISSCOAT customer service officer.

\* 1.74 Armour Sun UV++ **Coming Soon**

**SWISSCOAT Rx Power Range (Mineral)**

Index	Single Vision		Bifocal-Curve-top		Deluxe		Minipro	Genius		Office
	Clear	Transitions	Clear	Transitions	Clear	Transitions	Clear	Clear	Transitions	Clear
1.523	+6.00 ~ -8.00	+7.00 ~ -9.50	+7.50 ~ -8.00	+6.50 ~ -8.50	+6.00 ~ -6.00	+6.00 ~ -6.00	+4.50 ~ -5.00	N/A	N/A	+5.00 ~ -4.00
1.6	N/A	+9.00 ~ -9.00 (Brown) +3.00 ~ -7.50 (Grey)	+8.00 ~ -9.00	N/A	+7.00 ~ -8.50	+7.00 ~ -8.50	N/A	+5.50 ~ -9.00	+5.50 ~ -9.00	N/A
1.7	+9.00 ~ -16.00		N/A	N/A	N/A	N/A	N/A	N/A	N/A	N/A
1.8	-16.00 ~ -20.00		N/A	N/A	N/A	N/A	N/A	-15.00 ~ -18.50	N/A	N/A
1.9	-19.00 ~ -24.50		N/A	N/A	N/A	N/A	N/A	N/A	N/A	N/A
	N/A		ADD +1.00 ~ +3.00		ADD +0.75 ~ +3.00		ADD +1.00 ~ +3.50	ADD +1.00 ~ +3.00		ADD +075, +125, +175

Any power exceeds the power range, contact SWISSCOAT customer service officer.

## SWISSCOAT Rx Availability

		1.5	1.53 Trivex	1.59 PC	1.61	1.67	1.74
Coating Available	HC	✓	✓	✓	✓	✓	✓
	HCMC	✓	✓	✓	✓	✓	✓
	SPC	✓	✓	✓	✓	✓	✓
	MV	✓	✓	✓	✓	✓	✓
	SF	✓	✓	✓	✓	✓	✓
Tintable	-	✓	-	-	✓	✓ *	✓ **
Armour UV++	-	-	-	-	✓	✓	✓
*Armour Sun UV++	-	-	-	-	✓	✓	✓
SunAdapt	Brown/Grey	✓	-	-	✓	✓	-
Transitions Gen8	Brown/Grey	✓	✓	✓	✓	✓	✓
Transitions XTRActive	Grey	✓	✓	-	✓	✓	-
Polarized	Brown	✓	✓	✓	✓	✓	-
	Grey	✓	✓	✓	✓	✓	-
	Green	✓	-	✓	-	-	-
Drivewear	-	✓	-	✓	-	-	-

**COLOR DARKNESS** \* Red, Orange, Yellow, Green, Violet - 25% above  
Other Colors - No limitation

\*\* Red, Orange, Yellow, Green, Violet - 50% above  
Other Colors - 25% above

\* 1.74 Armour Sun UV++ **Coming Soon**

MYOPROTECH  
ADVANCE  
YOUNG BIFOCAL

## **OTHER** INFORMATION

SPORT  
SOLOTECH

# Lens Index Chart

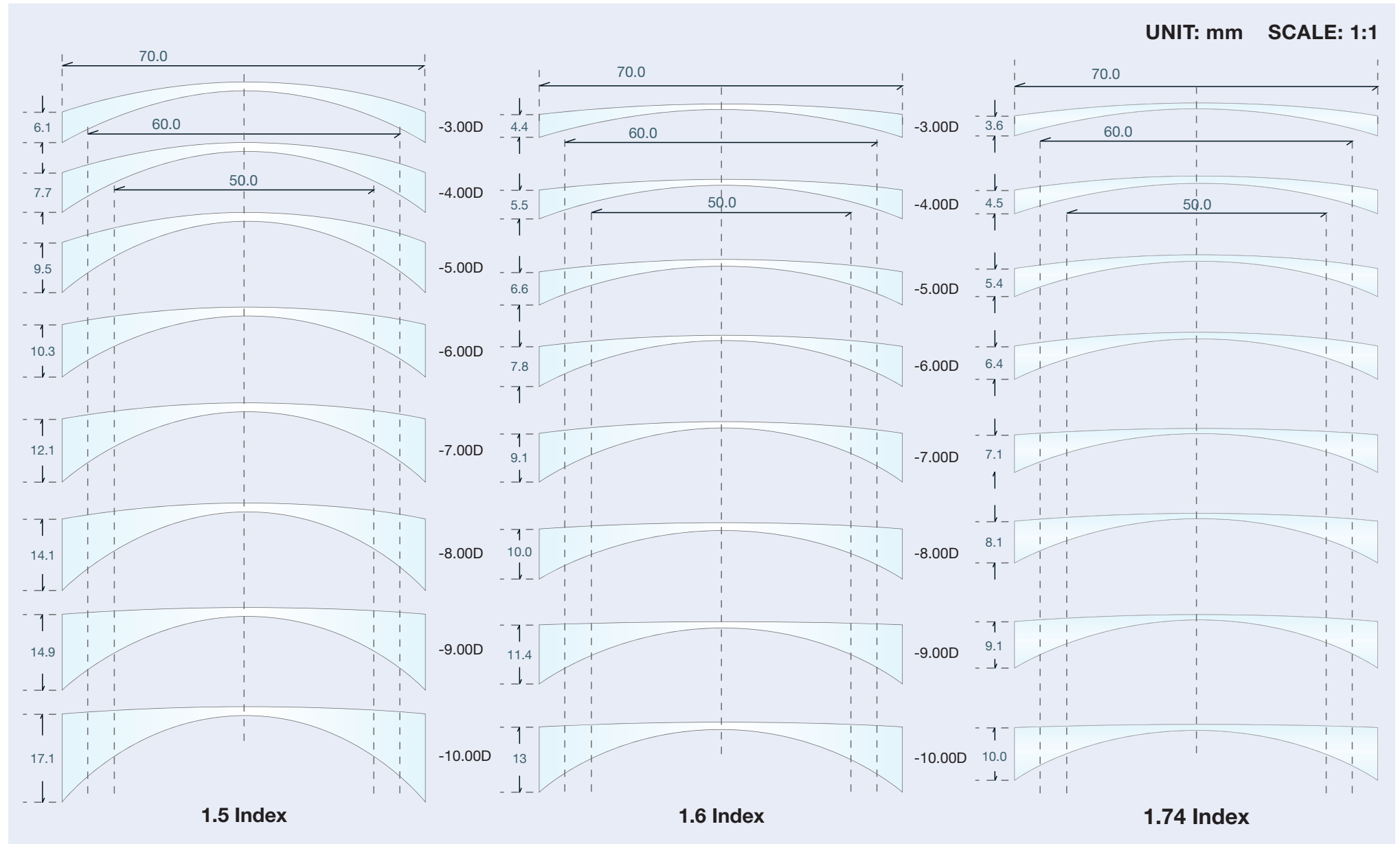

# Centration Chart

## iAction · iAction™

**Progressive**

MFH (15mm & 18mm Design)

## Precision Advance Kids Pro · Kids ProTECH

MFH (17/19/21mm Design)

## iFREE

MFH (14-20mm Design) (in 1mm Schritten)

## Genius

MFH (19mm)

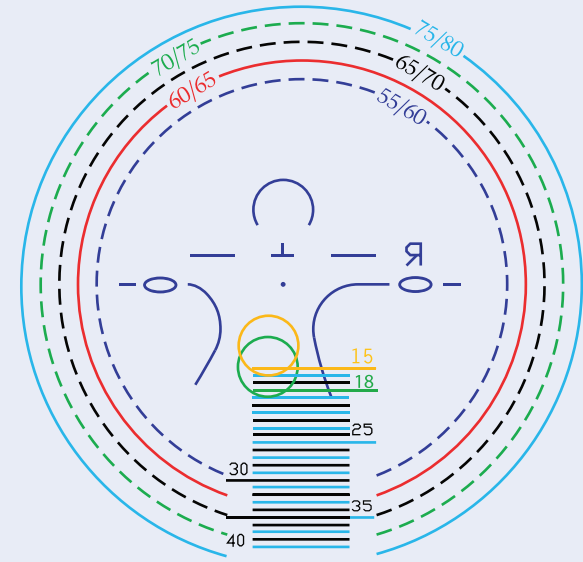
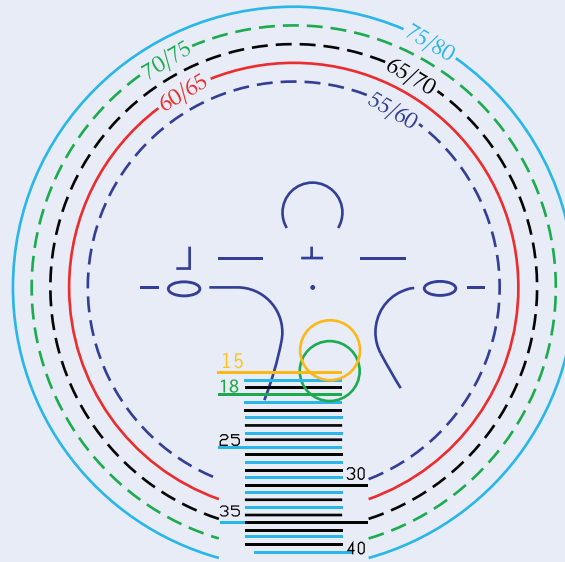

## Precision Daily · NECO

MFH (15/17/19mm Design)

## iRelax

MFH (17mm Design)

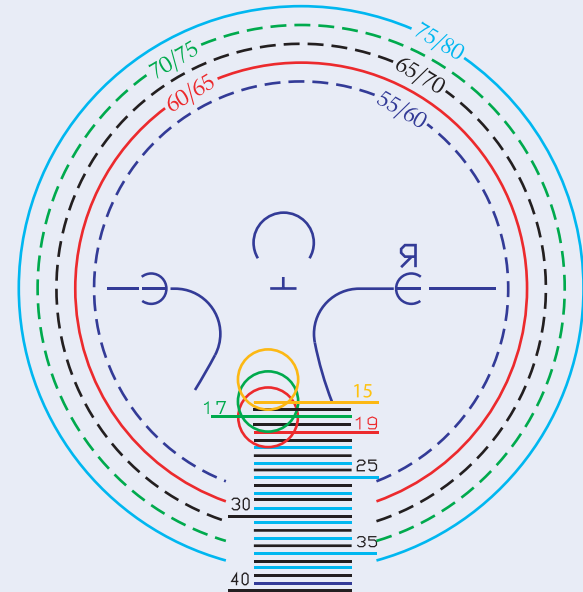
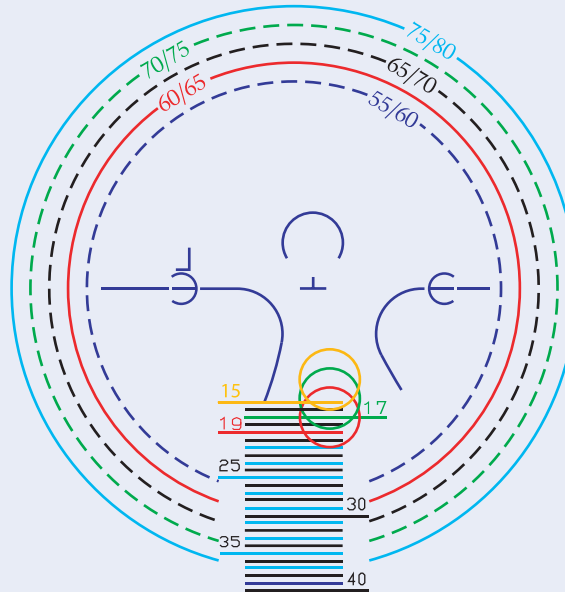



# Centration Chart

**Precision Office · Office  
iOffice · iRoom · iReader**  
MFH (16mm Design)

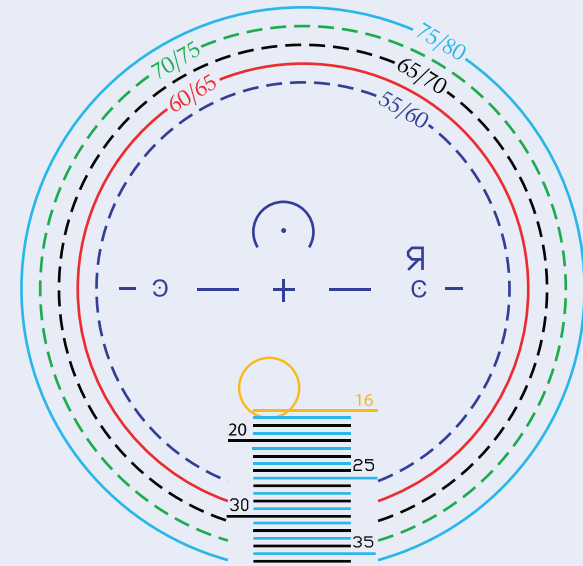
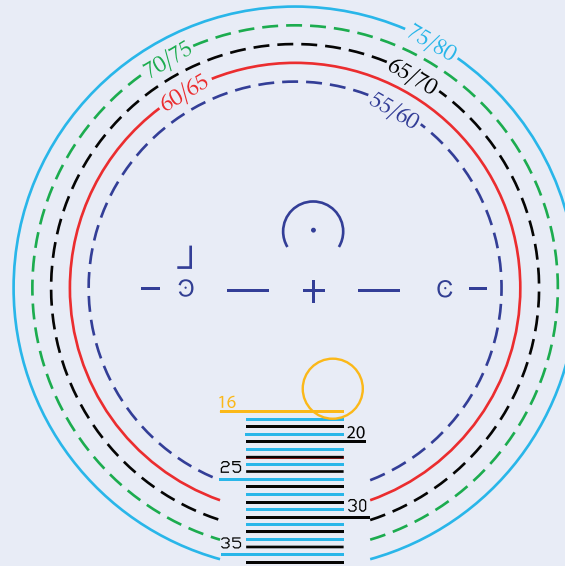

**iAction · iAction™**  
Single Vision

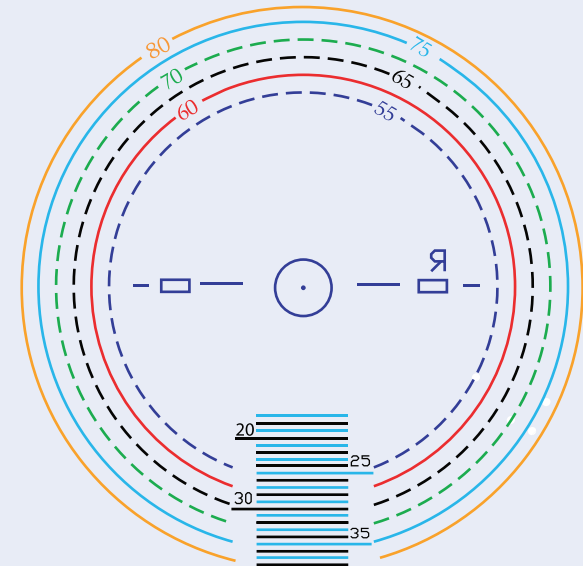
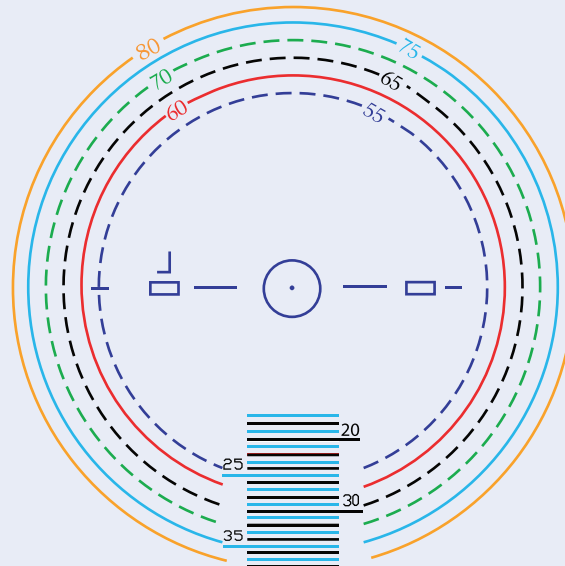

# Centration Chart

**Smart Evolution**  
**1.0/2.0/3.0**  
 MFH (16/18/20mm Design)

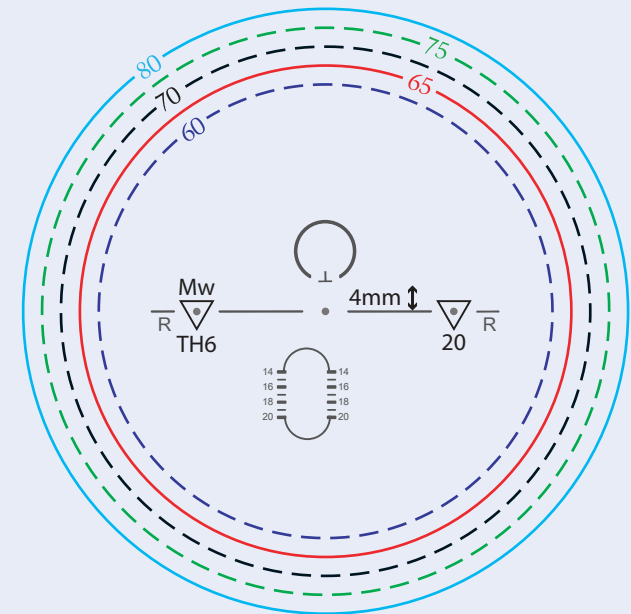
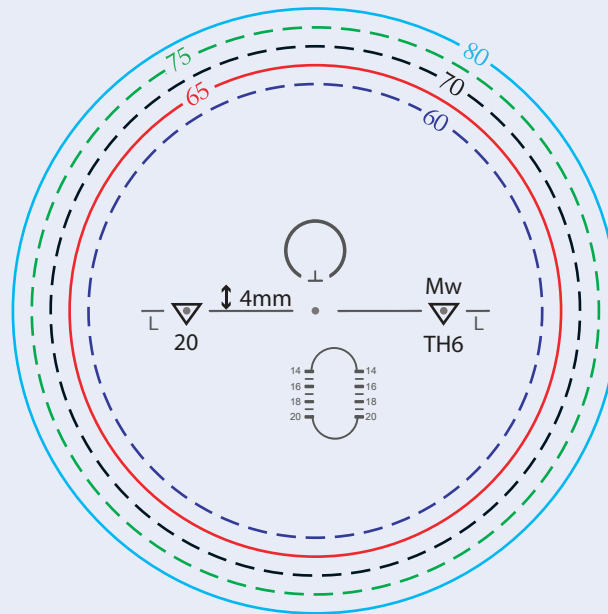

# Centration Chart

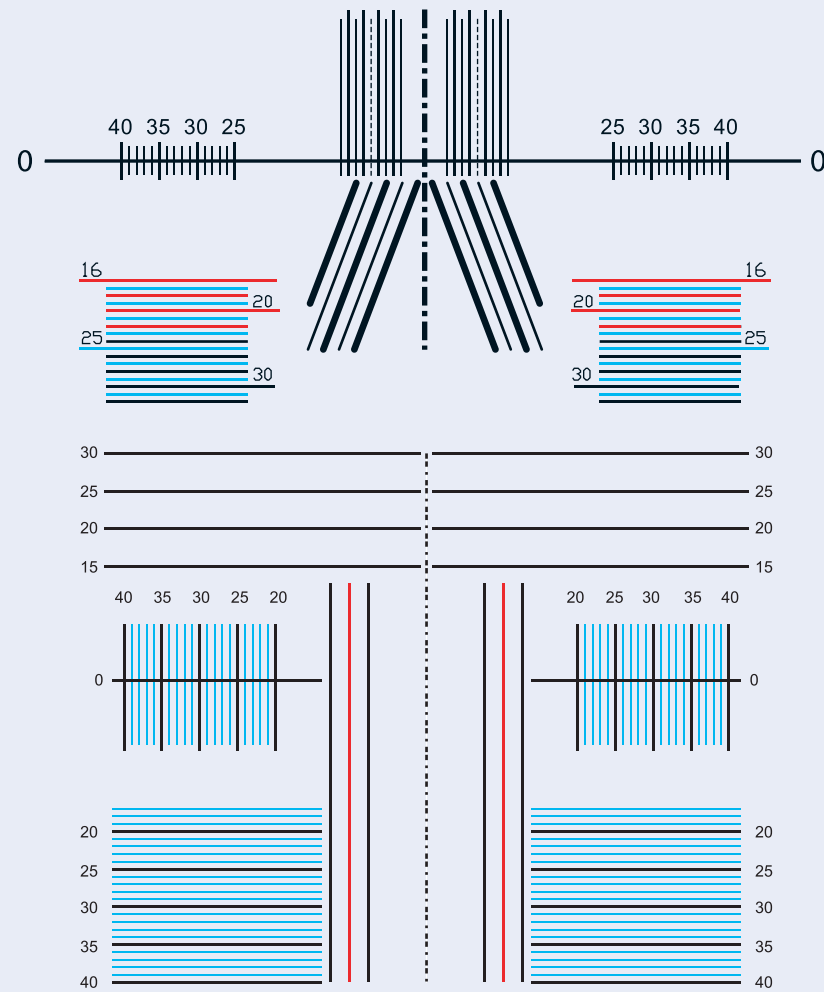

















# Lens Design Engraving

Index	Material	Material Engraving	Progressive Lens Corridor Length	Corresponding Corridor Length Marking	Complete Engraving Table						
1.5	Clear	E	14, 15, 16, 17, 18, 19, 20	4, 5, 6, 7, 8, 9, 20	E4	E5	E6	E7	E8	E9	E20
	Transitions	T			PE4	PE5	PE6	PE7	PE8	PE9	PE20
	Nupolar	Z			Z4	Z5	Z6	Z7	Z8	Z9	Z20
	Drivewear	W			W4	W5	W6	W7	W8	W9	W20
1.53 Trivex	Clear	V			V4	V5	V6	V7	V8	V9	V20
	Transitions	TV			TV4	TV5	TV6	TV7	TV8	TV9	TV20
	Nupolar	ZV			ZV4	ZV5	ZV6	ZV7	ZV8	ZV9	ZV20
1.586 PC	Clear	L			L4	L5	L6	L7	L8	L9	L20
	Transitions	TL			TL4	TL5	TL6	TL7	TL8	TL9	TL20
	Nupolar	ZL			ZL4	ZL5	ZL6	ZL7	ZL8	ZL9	ZL20
	Drivewear	WL			WL4	WL5	WL6	WL7	WL8	WL9	WL20
1.6	Clear/Armour UV++ Clear	H			H4	H5	H6	H7	H8	H9	H20
	Armour Sun UV++	PH			PH4	PH5	PH6	PH7	PH8	PH9	PH20
	Transitions	TH			TH4	TH5	TH6	TH7	TH8	TH9	TH20
	Nupolar	ZH			ZH4	ZH5	ZH6	ZH7	ZH8	ZH9	ZH20
1.67	Clear/Armour UV++ Clear	P			P4	P5	P6	P7	P8	P9	P20
	Armour Sun UV++	PP			PP4	PP5	PP6	PP7	PP8	PP9	PP20
	Transitions	TP			TP4	TP5	TP6	TP7	TP8	TP9	TP20
	Nupolar	ZP			ZP4	ZP5	ZP6	ZP7	ZP8	ZP9	ZP20
1.74	Clear/Armour UV++ Clear	U			U4	U5	U6	U7	U8	U9	U20
	*Armour Sun UV++	PU	PU4	PU5	PU6	PU7	PU8	PU9	PU20		
	Transitions	TU	TU4	TU5	TU6	TU7	TU8	TU9	TU20		























\* 1.74 Armour Sun UV++ **Coming Soon**





















# Lens Engraving Chart

PRECISION	Daily	 
	Sport	 
	Advance	 
HD PROGRESSIVE	NECO	 
MYOPIA CONTROL	KidsPro, Kids ProTECH	 
	MYO Protech	 
CONVENTIONAL PROGRESSIVE	MiniPro	 
	ECOS	 
	ECO, ECO57	 
	ECO Polarized	 
	Genius	 

INDOOR	Degressive Office	 
	iReader	 
	iRoom	 
	iOffice	 
SPORT	Daily Office	 
	iAction Progressive	 
	iAction Single Vision	 
MY WORLD	iFree	 
	iRelax	 
	iFree Short	 
	Smart Mobile	 

# Lens Engraving Chart

<b>MY WORLD</b>	iFree Super Soft	 
<b>Camber</b>	Balanced, Brginners Near, Distant	50  
<b>SE 1.0</b>	Mono	Sm  
	Glasses	Sm  
	Comfy	Sm  
	Reader	Y <sub>1</sub>  
	Office	Y <sub>2</sub>  
	Room	Y <sub>4</sub>  
	1SEP	Y <sub>6</sub>  
	Drive	SDr  
	Sport	SSp  

<b>SE 1.0</b>	All Round	 
	Learner	 
	Distant	 
	Mobile	 
<b>SE 2.0</b>	MaxiWide	Mw  
<b>SE 3.0</b>	MaxiWide Asian	Mwa  
<b>SE Drive</b>	Drive	SDr  
<b>SINGLE VISION</b>	Polarized	 
<b>FREEFORM BIFOCAL</b>	1KS28/1KS40	 
<b>PERSIONALIZE SINGLE VISION</b>	1UIN	 

# CONTACT US



## SWISSCOAT

23/F, One Midtown, 11 Hoi Shing Rd, Tsuen Wan, N.T., Hong Kong



+852 2751 8491



[info@swisscoat.com](mailto:info@swisscoat.com)



## VISIONPROLab. Swisscoat France

5 Rue Tronchet 75008 Paris France



+33 (0) 142 66 37 67



[contact@visionprolab.com](mailto:contact@visionprolab.com)



## SWISSCOAT EUROPE

Hauptstrasse 117 CH - 4450 Sissach Switzerland



+41 (0) 61 971 28 28



[contact@swisscoat.com](mailto:contact@swisscoat.com)



## Guang Zhou Eyetech Lens Laboratory Ltd.

SWISSCOAT Center One, 20 Meide 2nd Road, Zhujiang Street,  
Nansha, Guangzhou, China



+86 (20) 8497 5662



[info@swisscoat.com](mailto:info@swisscoat.com)

[www.swisscoat.com](http://www.swisscoat.com)